

EPIC® Rectangular Connectors



HA Plugs & Receptacles: Screw Terminated Inserts

HA 3/4 Inserts

HA 3

HA 4

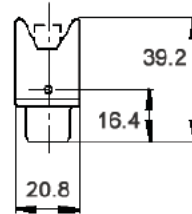
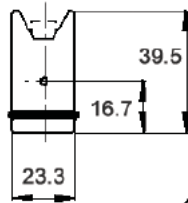

All dimensions are in mm.

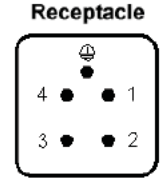
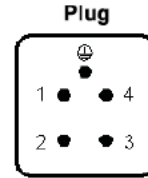
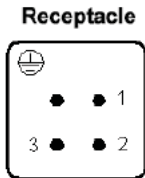
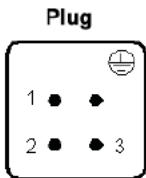

These inserts fit in the HA 3/4 Series Housings.

Description	Plug	Receptacle
HA 3	10420000	10421000
HA 4	10431000	10432000



Coding Pin: 10451200

HA 10 Inserts

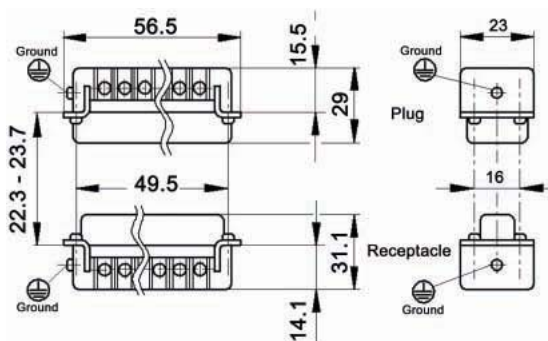

View from cable side

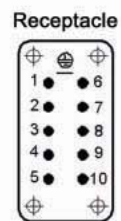
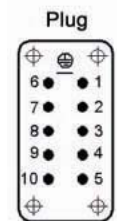

All dimensions are in mm.



Description	Plug	Receptacle
HA 10 with Wire Protection	10440100	10441100
HA 10 without Wire Protection	10440000	10441000

EPIC® Rectangular Connectors



HA Plugs & Receptacles: Screw Terminated Inserts

HA 16 Inserts

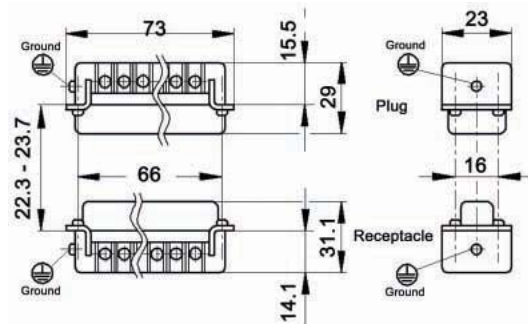
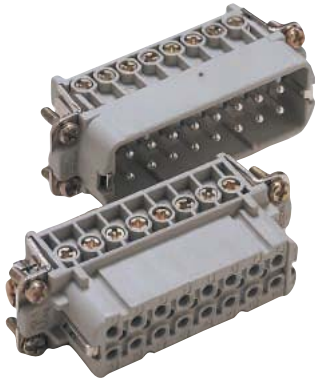

View from cable side

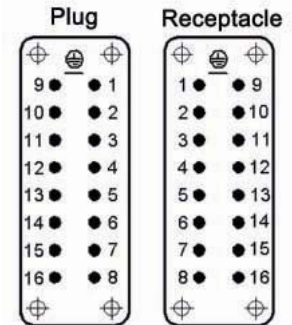

All dimensions are in mm.



Description	Plug	Receptacle
HA 16 with Wire Protection	10530000	10531000
HA 16 without Wire Protection	10532000	10533000

HA 32 Inserts

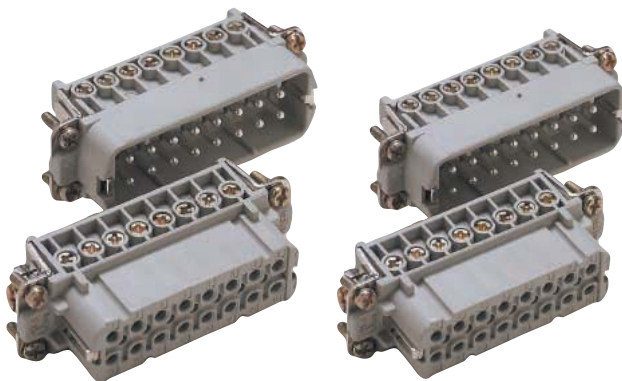

View from cable side

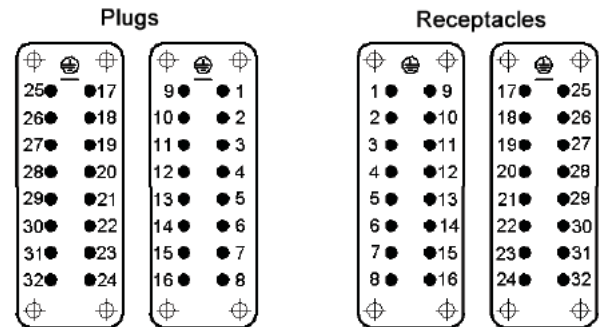

2 Sets of HA 16 Inserts

Description	Plug	Receptacle
#1-16 with Wire Protection	10530000	10531000
#17-32 with Wire Protection	10540000	10541000
#1-16 without Wire Protection	10532000	10533000
#17-32 without Wire Protection	10542000	10543000

STA 6 SCREW TERMINATED INSERTS



View from cable side

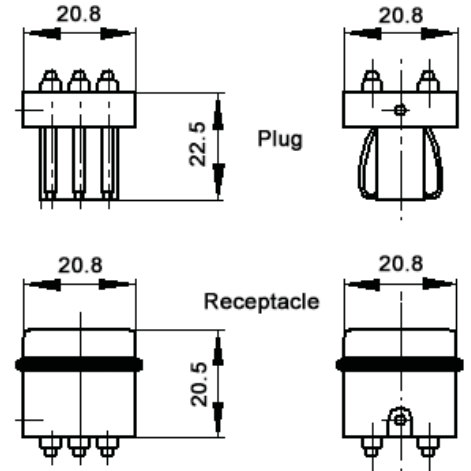
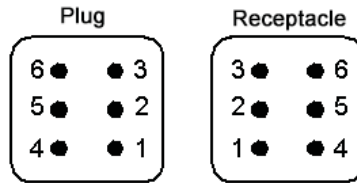

All dimensions are in mm.

Description	Plug	Receptacle
Screw Termination	10488100	10486100



SOLDER TERMINATED INSERTS



View from cable side

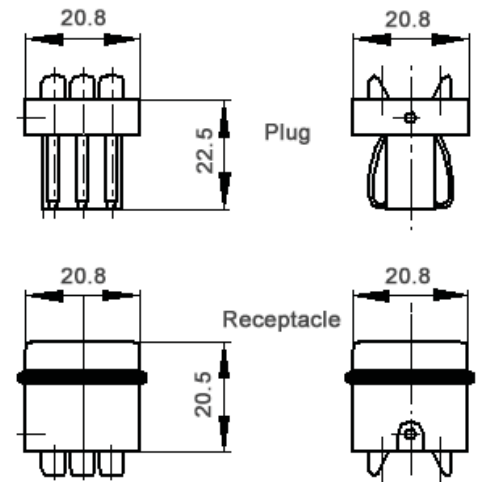
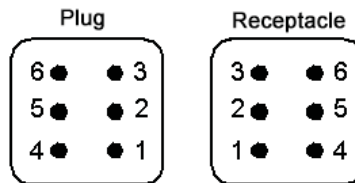

Description	Plug	Receptacle
Solder Termination	10487200	10485200

EPIC® Rectangular Connectors

HD Series



HD 25 CRIMP TERMINATED: STAMPED & FORMED CONTACT INSERTS

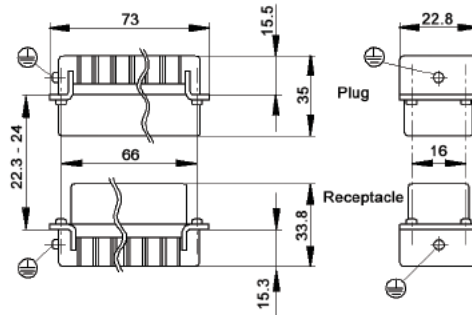

View from cable side

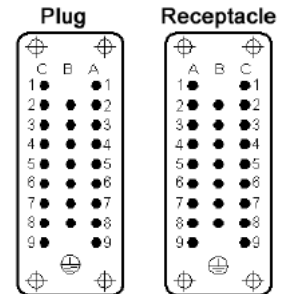

All dimensions are in mm.

Contacts Sold Separately

Plug	Receptacle
11260000	11261000



STAMPED & FORMED CONTACTS: DIAMETER 1.6 MM

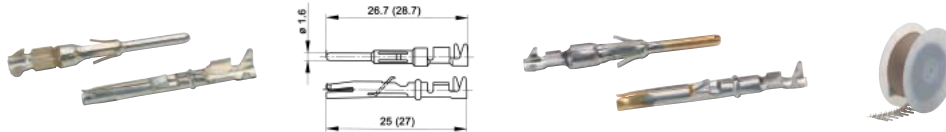

mm ²	Stripping Length (mm)
0.14 - 0.5	2.5 - 0.5
0.5 - 1.5	3.5 - 0.5
1.5 - 2.5	3.5 - 0.5

		Bags of 100: Silver		Bags of 100: Gold		Reel of 100: Silver Left Hand Feed		Reel of 200: Silver Left Hand Feed	
mm ²	AWG	Pin	Socket	Pin	Socket	Pin	Socket	Pin	Socket
0.14 - 0.5	26 - 20	11241100	11231100	11243100	11233100	-	-	11240700	11230700
0.5 - 1.5	20 - 16	11221000	11236100	11221300	11238100	-	-	11220700	11235700
1.5 - 2.5	16 - 14	11223500	11228500	-	-	11223000	11228000	-	-

mm ²	AWG	Reel of 2000: Right Hand Feed- Silver		Reel of 2000: Right Hand Feed- Gold		Reel of 2000: Left Hand Feed- Silver		Reel of 2000: Left Hand Feed- Silver	
		Pin	Socket	Pin	Socket	Pin	Socket	Pin	Socket
0.14 - 0.5	26 - 20	11240000	11230000	-	-	11240400	11230400	11230500	11240500
0.5 - 1.5	20 - 16	11220000	11235000	11220100	11235200	11226000	11226500	-	-
1.5 - 2.5	16 - 14	-	-	-	-	11222700	11227700	-	-

Part number= 1 contact (bags) or 1 reel.



Crimp Tool
11147000



Locator
11147300



Removal Tool: 11161000



Crimp Tool for Reel:
11153500



Crimp Dies
0.14-0.5: 11147170
0.5-1.5: 11147180
1.5-2.5: 11147190

Crimp Dies for Reel:
0.14-0.5: 11153600
0.5-1.5: 11153700
1.5-2.5: 11153800



EPIC® Rectangular Connectors



HA 10 Housings: Single Lever on Base

TOP & SIDE ENTRY HOODS

TOP ENTRY

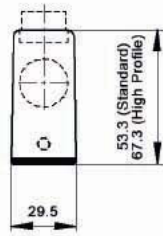

All dimensions are in mm.

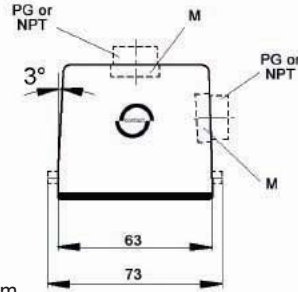

SIDE ENTRY



Specifications: DIN 43652
Temperature Range: -40°C to +125°C

Protection class: NEMA 4, NEMA 12, IP65
Material: Aluminum alloy, powder coated

STANDARD PROFILE

Position of Cable Entry	Size of Entry			Part Numbers			Complete your installation with a SKINTOP®, Pg 352			
	PG	NPT	Metric	PG	NPT	Metric	PG- Nylon	PG- Metal	Metric- Nylon	Metric-Metal
Top Entry	13	1/2"	20	10446000	104460NP	19446000	53015130	52015730	53111020	53112020
	16	1/2"	25	10446100	104461NP	19446100	53015140	52015740	53111030	53112030
Side Entry	16	1/2"	20	10445000	104450NP	19445000	53015140	52015740	53111020	53112020
	21	3/4"	25	10445500	104455NP	19445500	53015150	52015750	53111030	53112030

Top Entry Metric hoods do not come with a neck.

HIGH PROFILE

Position of Cable Entry	Size of Entry			Part Numbers			Complete your installation with a SKINTOP®, Pg 352			
	PG	NPT	Metric	PG	NPT	Metric	PG- Nylon	PG- Metal	Metric- Nylon	Metric-Metal
Top Entry	16	1/2"	20	70460200	704602NP	79460200	53015140	52015740	53111020	53112020
	21	3/4"	25	70460400	704604NP	79460400	53015150	52015750	53111030	53112030
Side Entry	16	1/2"	20	70462200	704622NP	79462200	53015140	52015740	53111020	53112020
	21	3/4"	25	70462400	704624NP	79462400	53015150	52015750	53111030	53112030

High Profile Metric hoods do not come with a neck.



PANEL MOUNT BASES

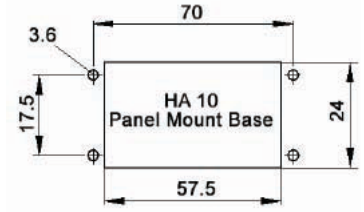
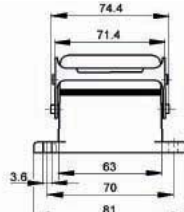
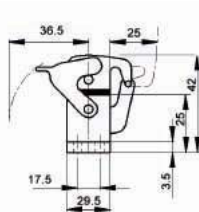

Without Dust Cover	With Dust Cover
104420C0	704440C0

All dimensions are in mm.

DUST COVERS WITH OR WITHOUT ATTACHMENT STRING

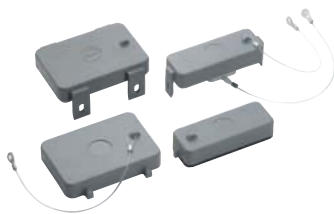

Material:	Thermoplastic Resin	Temperature:	-40°C to +125°C
Description	Part # with string	Part # without string	
HA 10 Panel Mt or Surface Mt Base/ Cable Coupler hoods (includes gasket)	10457500	10457700	
Dust cover for HA 10 Hoods	10457600	10457800	

EPIC® Rectangular Connectors



HA 16 Housings: Single Lever on Base

TOP ENTRY

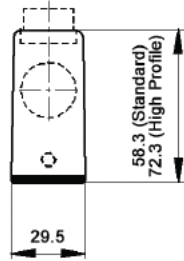

HOODS

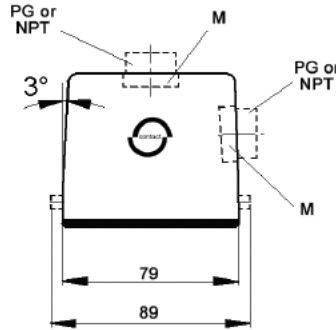

SIDE ENTRY



STANDARD PROFILE

Position of Cable Entry	Size of Entry			Part Numbers			Complete your installation with a SKINTOP®, Pg 352			
	PG	NPT	Metric	PG	NPT	Metric	PG- Nylon	PG- Metal	Metric- Nylon	Metric-Metal
Top Entry	16	1/2"	20	10565000	105650NP	19565000	53015140	52015740	53111020	53112020
	21	3/4"	25	10565200	105652NP	19565300	53015150	52015750	53111030	53112030
Side Entry	16	1/2"	20	10564000	105640NP	19564000	53015140	52015740	53111020	53112020
	21	3/4"	25	10564500	105645NP	19564500	53015150	52015750	53111030	53112030

Top Entry Metric hoods do not come with a neck.

HIGH PROFILE

Position of Cable Entry	Size of Entry			Part Numbers			Complete your installation with a SKINTOP®, Pg 352			
	PG	NPT	Metric	PG	NPT	Metric	PG- Nylon	PG- Metal	Metric- Nylon	Metric-Metal
Top Entry	16	1/2"	20	70490200	704902NP	79490200	53015140	52015740	53111020	53112020
	21	3/4"	25	70490400	704904NP	79490400	53015150	52015750	53111030	53112030
Side Entry	16	1/2"	20	70492200	704922NP	79492200	53015140	52015740	53111020	53112020
	21	3/4"	25	70492400	704924NP	79492400	53015150	52015750	53111030	53112030

High Profile Metric hoods do not come with a neck.

PANEL MOUNT BASE

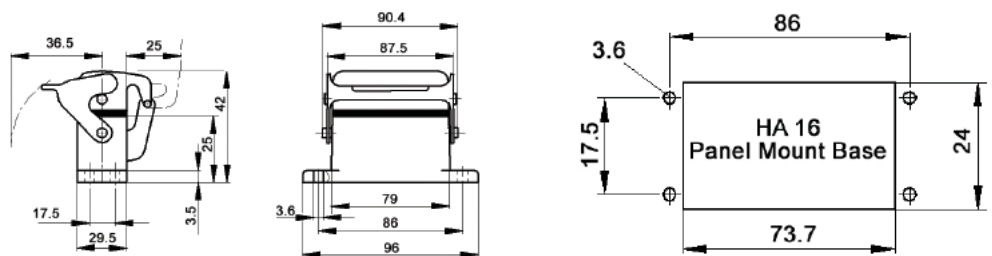

Without Dust Cover	With Dust Cover
104620C0	704740C0

DUST COVERS WITH OR WITHOUT ATTACHMENT STRING



Material:	Thermoplastic Resin	Temperature:	-40°C to +125°C
Description	Part # with string	Part # without string	
HA 16 Panel Mt or Surface Mt Base/ Cable Coupler hoods (includes gasket)	10469500	10469700	
Dust cover for HA 16 Hoods	10469600	10469800	

EPIC® Rectangular Connectors



HA 3/4 Housings: Single Lever on Base

TOP & SIDE ENTRY HOODS

TOP ENTRY

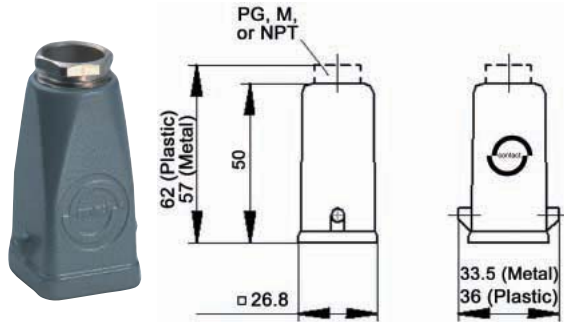

All dimensions are in mm.

SIDE ENTRY

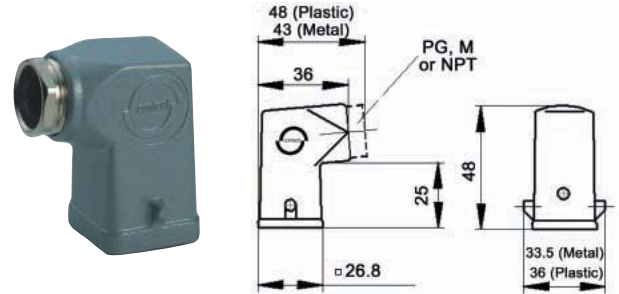

Specifications: DIN 43652
Temperature Range: -40°C to +125°C

Protection class: NEMA 4, NEMA 12, IP65
Material: Aluminum alloy, powder coated

Top Entry Hoods

Material	Size of Entry			Without Cable Gland		With Cable Gland	
	PG	NPT	Metric	NPT	Metric	PG	Metric
Zinc Die Cast	11	1/2"	20	105121NP	-	10426500	19426500
Black Plastic	11	1/2"	20	104255NP	19425500	10426700	-
Grey Plastic	11	1/2"	20	104260NP	19426000	10426400	-

Side Entry Hoods

Material	Size of Entry			Without Cable Gland		With Cable Gland	
	PG	NPT	Metric	NPT	Metric	PG	Metric
Zinc Die Cast	11	1/2"	20	105123NP	-	10427500	19427500
Black Plastic	11	1/2"	20	104273NP	19427300	10620600	-
Grey Plastic	11	1/2"	20	104270NP	19427000	10427100	-

PANEL MOUNT BASES

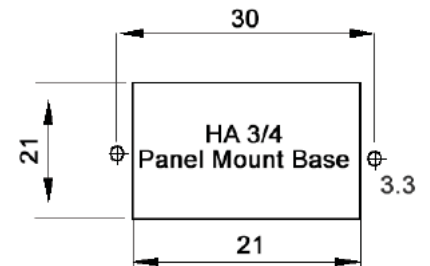
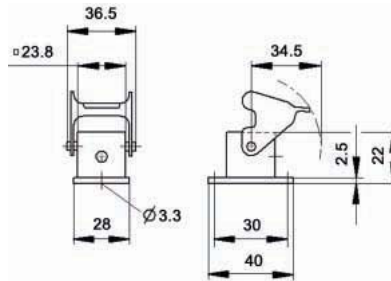

Gray Metal	Black Plastic	Gray Plastic
10422500	10422200	10422000

All dimensions are in mm.

ANGLED PANEL MOUNT BASES

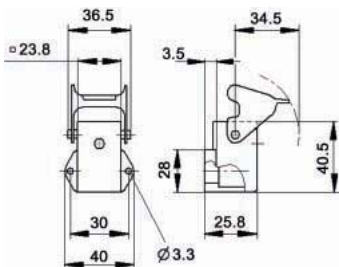

Gray Metal	Black Plastic	Gray Plastic
10423500	10423100	10423000

