

eWON COSY 141 - Installation Guide



Contents

This short guide explains how to install eWON COSY 141 and to get started with the embedded configuration web site.

1. Foreword.....	3
2. Hardware description.....	3
2.1 Housing interfaces.....	3
2.2 Markings.....	4
2.3 Applicable directives, standards and compliance.....	4
2.4 Mechanical outline.....	5
2.5 Mounting and environmental conditions.....	6
2.6 External power supply characteristics.....	6
2.7 Front panel status LEDs.....	7
2.8 Ethernet ports.....	7
2.8.1 Machine LAN.....	7
2.8.2 Internet port.....	7
2.9 Serial-ports.....	8
2.9.1 Configurable serial port.....	8
2.9.2 MPI port.....	9
2.10 Digital input – Digital output.....	10
3. Software configuration.....	12
3.1 Factory default IP settings.....	12
3.2 Selecting the appropriate LAN IP address.....	12
3.3 Setting the eWON COSY Machine LAN IP address.....	13
3.4 eWON COSY's web interface	14
3.4.1 Accessing the eWON COSY.....	14
3.4.2 Going through the 1-2-3 Setup Wizard.....	15
3.5 Status pages.....	16
4. Troubleshooting.....	18
4.1 Resetting the eWON COSY.....	18
4.2 First level reset.....	18
4.3 Second level reset.....	18
Revision history.....	20
5. General characteristics of eWON COSY.....	19

1. Foreword



The present Installation Guide describes the hardware and software features of the eWON COSY. It does not address the 1-2-3 Setup procedure that is explained in 3 hands-on videos you can watch here: <http://support.ewon.biz/cosy.htm>

2. Hardware description

2.1 Housing interfaces



①	Power supply (polarity sensitive, see label). See External power supply characteristics .
②	Digital IO (Internet port control & status). See Digital input – Digital output .
③	Status LEDs. See Front panel status LEDs .
④	Reset button hole. See Troubleshooting .
⑤	LAN Ethernet 10/100 switch 4 ports. See Machine LAN .
⑥	Controlled Internet port 10/100. See Internet port .
⑦	RS232/422/485 port or MPI-port (no galvanic isolation). See Serial-ports .
⑧	Ground screw
⑨	Location of DIN-rail latch. See Mounting and environmental conditions .

2.2 Markings

The identification label of the eWON is placed at the left hand side of the housing. The different parts of the label are shown below:

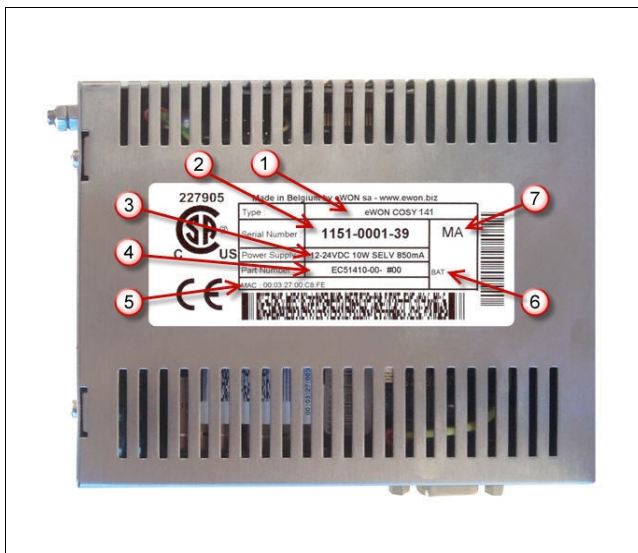
	①	Device type and interfaces
	②	Serial number 1145 = year+week 0062 = sequential number 39 = suffix COSY RS232/422/485 40 = suffix COSY MPI
	③	Power supply requirements. See External power supply characteristics
	④	Commercial part number
	⑤	MAC address
	⑥	Hardware features: BAT = battery for RTC
	⑦	Firmware language set ID MA (English, German, French)

2.3 Applicable directives, standards and compliance

Aspect	Standard N°	Title
EMC CE-mark ¹	2004/108/EC	Electromagnetic Compatibility Directive
Safety cCSAus mark Certificate N° 227905 ²	IEC/EN60950 CAN/CSA C22.2 NO. 60950-1-07 ANSI/UL UL 60950-1	Information Technology Equipment - Safety - Requirements
Emissions	EN55022	Information Technology Equipment - Radio Disturbance Characteristics - Limits and Methods of Measurement
Immunity	EN55024	Information Technology Equipment-Immunity Characteristics- Limits and Methods of Measurement
Environment (vibration & climatic)	IEC 60068- 2-1 2-2 2-14 2-29 2-30 2-64	Environmental testing Cold Dry heat Change of temperature Bump Damp heat (cyclic) Vibrations
Environment (Ingress Protection) IP30	IEC 60529	Degrees of Protection Provided by Enclosures

1 To check our CE *Declaration of Conformity* click the link below:

2 To check our cCSAus *Certificate of Compliance* click the link below:
http://wiki.ewon.biz/Support/07_Documentations/Official_documents

2.4 Mechanical outline

The recommended free space in the cabinet for the eWON should be at least: 40-mm wide x 200-mm high x 160-mm deep (includes space for smooth cable bending).

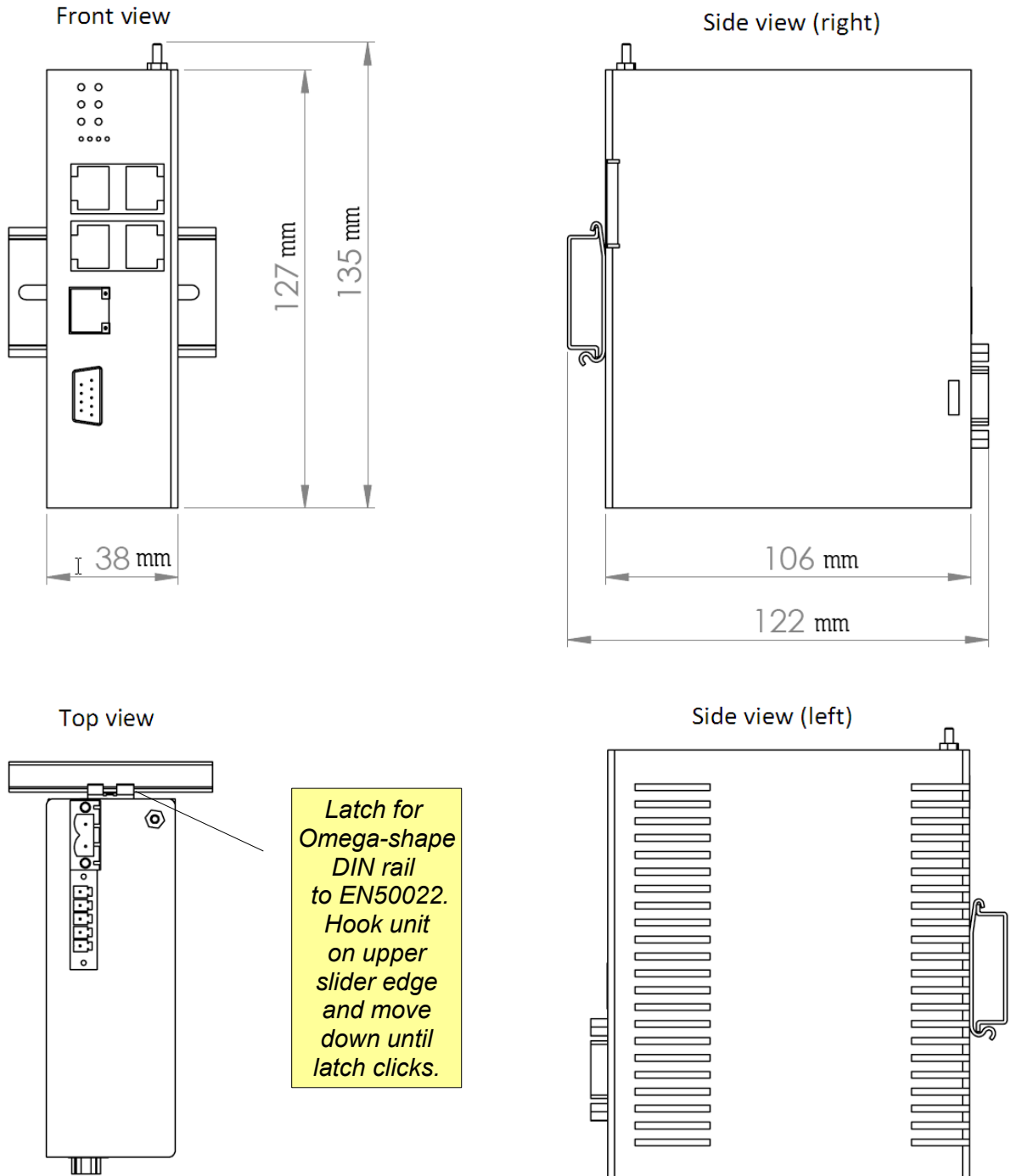

2.5 Mounting and environmental conditions

The eWON COSY unit has an IP30 protection grade. It is therefore not suited for outdoor mounting. The design of the unit is such that it has to be integrated in an enclosed electrical cabinet, protected from excessive heat humidity and dust.

The eWON COSY complies to the CE-marking requirements regarding electromagnetic compatibility (EMC) within an industrial environment. The normal mounting position is wall mounted on [Omega type DIN-rail \(EN 50022\)](#). The unit is suited to work in any other position.

Grounding the eWON is necessary to eliminate unwanted transients (lightning protection) and to conform to the EMC requirements. Therefore, a ground screw is available at the top of the unit. Connect this screw directly to a low impedance ground.

The equipment will operate properly provided it remains within specified environmental limits (see § 5 [General characteristics of eWON COSY](#))

2.6 External power supply characteristics

The eWON COSY has to be powered by an external voltage source. The power supply used should be a [Class III, SELV-compliant](#). The safety voltage power supply is not part of the delivery.

Characteristic	Value
Power supply voltage	External 12-24 VDC +/- 20% Current limited to an absolute max. of 850 mA.
Power consumption	10W max.
Internal current protection	2A by auto fuse (*)
Internal voltage protection	30V by transil
2-pin PS connector Polarity	
Female mating connector <i>included in delivery</i> ref: MSTB 2,5/2-STF-5.08	

(*) This component normally returns to its normal state by itself after cooling down. Would this fuse happen to operate, please check the device for presence of loose metal parts inside. If the problem recurs even after such a verification, then you should return the device to the vendor for further investigation.

2.7 Front panel status LEDs

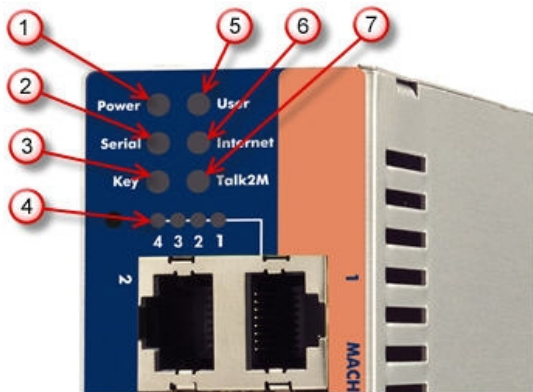

- ① Power (green = VDC present)
- ② Serial/MPI port activity (green = RX)
- ③ Ethernet port key status (green = ON, DI = 1)
- ④ Activity on LAN-ports (green steady = TX)
- ⑤ User = device life status bi-color LED
Flashing green = life (20 secs after power on)
- ⑥ Internet access configuration (green = OK)
- ⑦ VPN-tunnel status (green = OK, DO = 1)

2.8 Ethernet ports

By default, only the LAN Ethernet interface of the eWON COSY can be used to access the internal web site.

2.8.1 Machine LAN

The Machine LAN interface consists of a four port autosense Ethernet switch (10/100 Mb). Autosense meaning that you can use both UTP Class 5 direct and crossed cables with RJ45 terminations at both ends. Each port has its own activity LED. The following table describes the possible status of these.

Color & activity	Meaning
Off	No link
Green steady	Ethernet link OK
Green blink	Ethernet traffic (Rx and Tx)

2.8.2 Internet port

Note: the ability to enable/disable the Internet port based upon the digital input (see § 2.10 Digital input – Digital output) requires configuration in the eWON configuration wizard.

The eWON can access the Internet through its 10/100BaseTX Internet connection. This port is not autosense but in most cases the counterpart will be. Therefore UTP Class 5 (straight or crossed) with RJ45 terminations at both ends will fit. The Internet port has 2 LEDs showing the status and activity on this port. The following table describes the possible status of these.

LED location	Color & activity	Meaning
Upper LED	Off	No link
	Green steady	Ethernet link OK
Lower LED	Green blink	Ethernet traffic (Rx and Tx)

2.9 Serial-ports

2.9.1 Configurable serial port

The configuration of the physical serial mode is done by a set of 4 dip switches located on left side of the unit. The settings of the switches are shown in the table below:

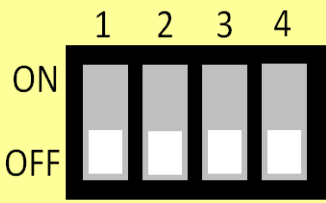
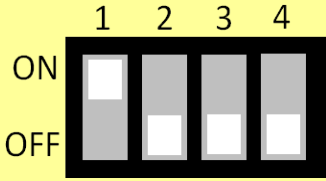
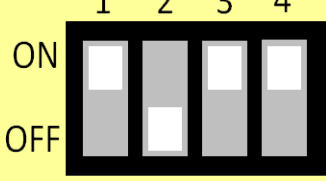
Dip switch positions	Serial mode
	RS232
	RS422, RS485 without polarization and termination resistors
	RS422, RS485 with polarization (680 Ω) and termination (120 Ω) resistors

Note: the 3 switch configurations shown above are the only functional configurations.

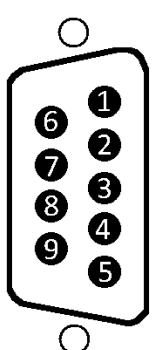
Characteristic	Value				
Physical modes	RS232/422/485 (no galvanic isolation)				
Polarization	680 Ω (if polarization & termination is activated)				
Termination	120 Ω (if polarization & termination is activated)				
SUBD9 connector pinout	Pin #	RS232	RS485	RS422	
	1	-	-	-	
	2	RXD	-	Rx+	
	3	TXD	A+	Tx+	
	4	-	-	-	
	5	GND	GND	GND	
	6	-	-	-	
	7	RTS	-	Rx-	
	8	CTS	B-	Tx-	
	9	-	-	-	

2.9.2 MPI port

The MPI version of the eWON COSY is easily identifiable with its light turquoise square surrounding the SUBD9 female DB9 connector.

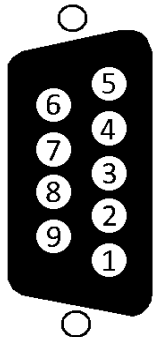
Characteristic	Value		
Physical mode	MPI (no galvanic isolation)		
Baud rates	From 9,6 kBauds to 12,0 MBauds		
Polarization	100 k Ω		
Termination	None		
SUBD9 female connector pinout	Pin #	MPI	
	1	-	
	2	-	
	3	B+	
	4	-	
	5	GND	
	6	-	
	7	-	
	8	A-	
	9	-	

2.10 Digital input – Digital output

The eWON COSY features one Digital Input (DI) to enable/disable the Internet port from outside and one Digital Output (DO) that returns the status of the VPN tunnel connection. The DI and DO cannot be allocated to other functions.

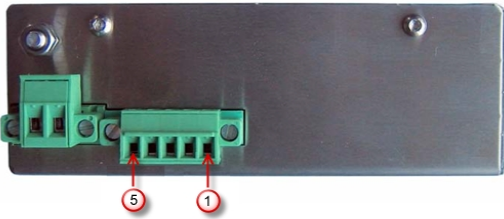
Characteristic	Value		
DI state (requires configuration to operate)	OFF state = Internet port is disabled ON state = Internet port is enabled		
DI voltage range	0 to 24 VDC		
DI voltage max. (varistor protection)	33 VDC		
DI OFF state input voltage range	0 to 5 VDC		
DI ON state input voltage range	10 to 30 VDC		
DI ON state current range	From 3,8 mA @ 12 VDC to 8,2 mA @ 24 VDC		
DO state	OFF state = VPN tunnel is not established ON state = VPN tunnel is established (*)		
Type of digital output	Open drain MOSFET		
Max. current (ext. source)	200 mA @ 30 VDC		
Isolation (both DI and DO)	3,5 kV		
5-pin IO connector Pinout Female mating connector <i>included in delivery</i> ref: CTF050VT	Pin #	ID	Description
	1	DO_GND	Output signal (0V ground) <i>connected to the emitter of the MOSFET transistor</i>
	2	DO	Output signal <i>connected to the drain of the MOSFET transistor</i>
	3	DO_VDC	Common of the external predrive power supply (between +12 et +24 VDC)
	4	DI_GND	Ground of the input (isolated)
	5	DI	Input signal
			

(*) when the eWON COSY reboots, a short phase of ON state is part of the starting process.

The digital output is activated by an open drain MOSFET transistor driven by an optocoupler. The maximum current flow into this transistor has a characteristic above the value specified in the eWON, in order to cope with the switching power losses. The transistor used is in an open drain type with predrive. This means the relay power supply has to be supplied from an external source to the predrive electronics. The diagram below shows the external wiring needed for correct operation of the digital output. A relay has been chosen for this sample application but any load within the specifications can be used instead.

Note: this is a sink only output to ground (the transistor acts like a switch to ground).

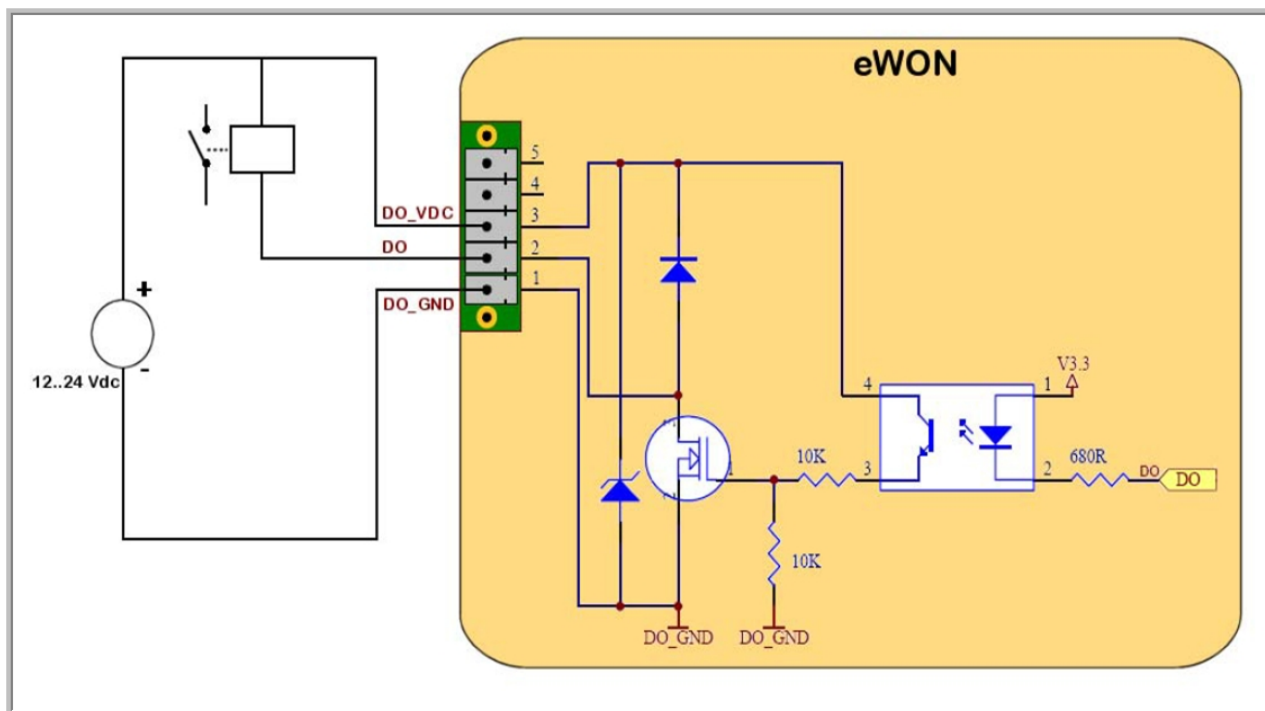

3. Software configuration

3.1 Factory default IP settings

Characteristic	Value
Machine LAN IP address	10.0.0.53
Machine LAN Subnet Mask	255.255.255.0
Internet port IP address	10.1.0.53
Internet port Subnet Mask	255.255.255.0
Internet port Gateway	0.0.0.0

3.2 Selecting the appropriate LAN IP address

Configuring remote access with our Talk2M solution is simple. However, you need to pay attention to the different IP ranges of involved networks. Example of networks involved during the remote access :

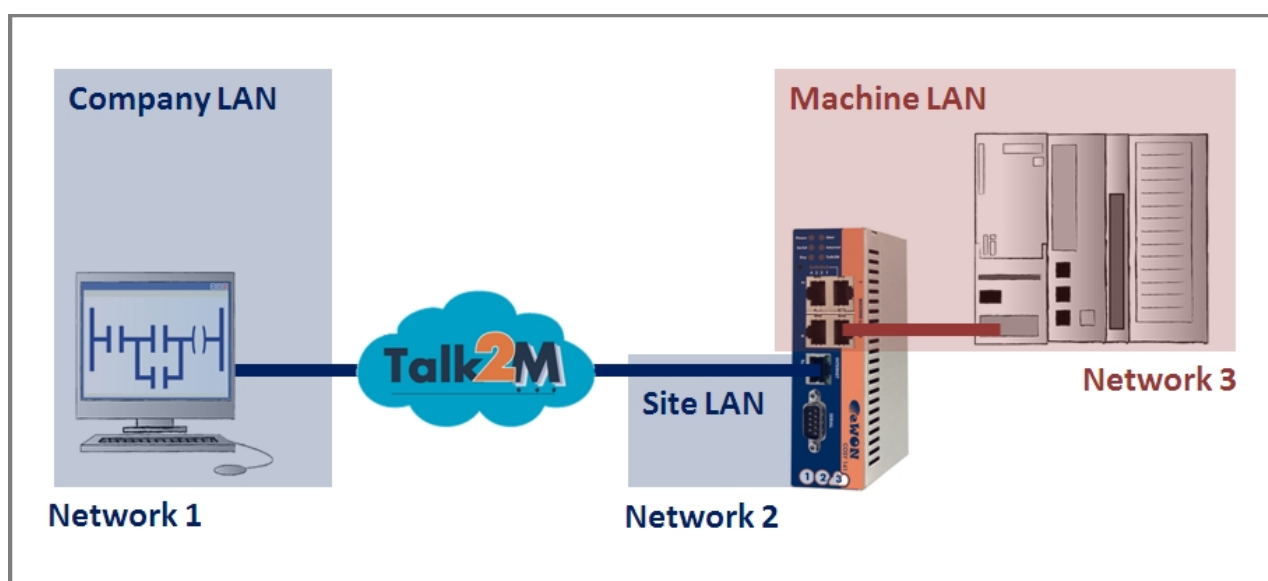

To allow routing to the devices connected to the eWON Machine LAN, following conditions must be complied:

Network 1 <> Network 3:

Company LAN address range must differ from eWON Machine LAN address range.

Network 2 <> Network 3:

Site LAN address range (= eWON Internet access) must differ from eWON Machine LAN address range.

The company network address ranges (Company LAN and Site LAN in the example above) are specified and managed by the respective network administrators. These ranges simply cannot be changed. Most of the time the IP addresses are defined by DHCP servers. IP parameters always have to be defined in full agreement with network policies applicable within the network organization (ask the network administrator).

Knowing the ranges in use at the Company and Site side, you must select for the eWON Cosy Machine LAN a range outside these networks.

For more details see: http://wiki.ewon.biz/Cosy/0_Set_eWON_Machine_LAN_IP_address

3.3 Setting the eWON COSY Machine LAN IP address

You can easily communicate with your eWON by using a special tool called **eBuddy** you can download from <http://ftp.ewon.biz/software/eBuddy/eBuddySetup.exe>

Connect one of the Machine LAN-ports of your eWON COSY to the same network as your PC. Start the eBuddy application. The application will scan the whole network and will identify all eWONs that are connected, including their IP Address, Subnet Mask and serial number. The utility allows also you to edit the IP parameters.

For more details see: http://wiki.ewon.biz/Cosy/0_Set_eWON_Machine_LAN_IP_address

3.4 eWON COSY's web interface



This section covers only the basic principles of the eWON COSY 1-2-3 Setup. Each step of the 1-2-3 Setup is documented by a hands-on video tutorial. Go to the eWON COSY support page <http://support.ewon.biz/cosy.htm> to view these videos.

3.4.1 Accessing the eWON COSY

We assume that you reconfigured the LAN IP address as explained in § 3 Software configuration. Connect your PC with one of the LAN ports, make sure your PC has an IP address in the same range as the one of the eWON COSY, open your Internet Browser and, in the URL address field, enter the actual LAN address you configured in the eWON COSY:

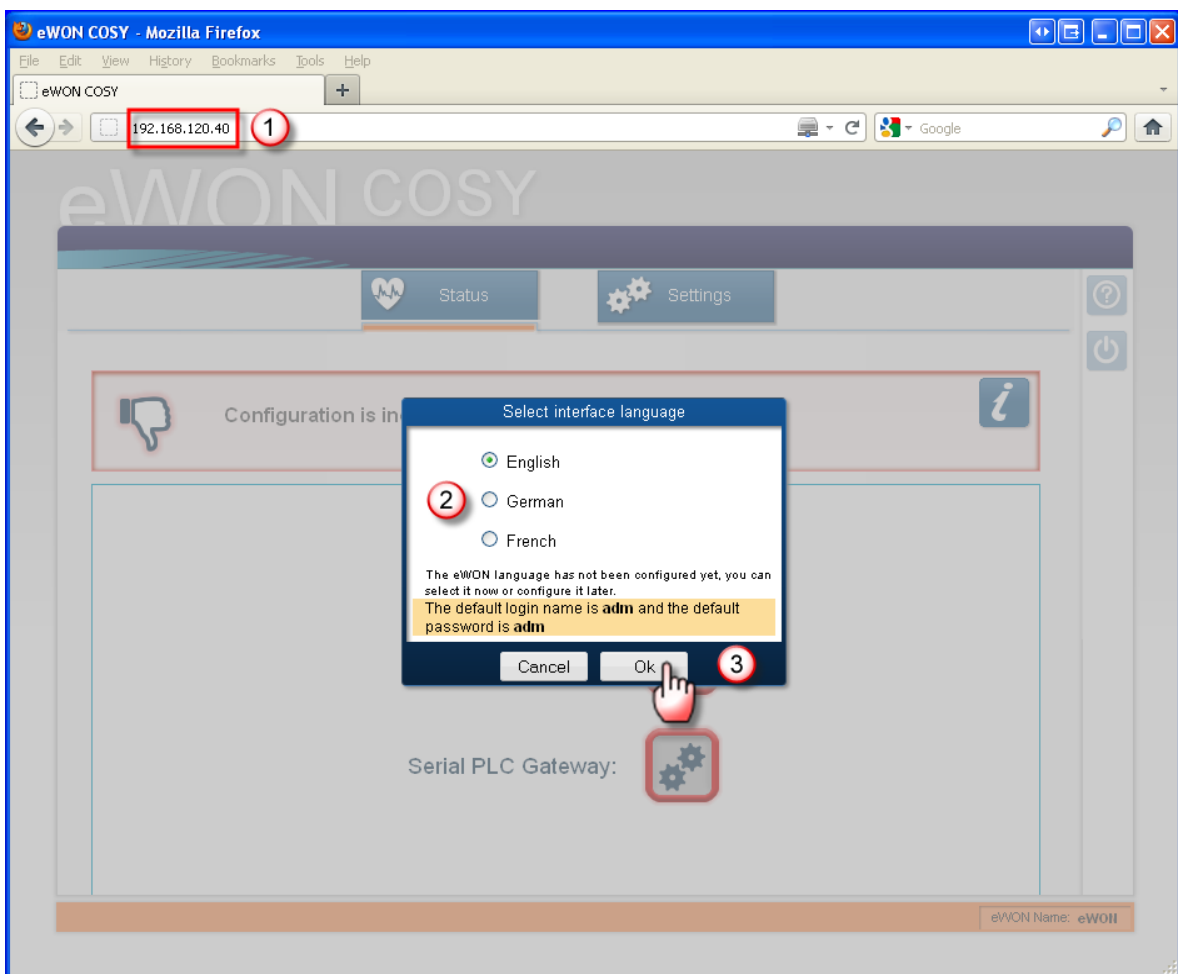

- ① Enter the LAN IP address of the eWON COSY
- ② Select the preferred language for the interface (this window opens only the first time)
- ③ Click OK to continue

Note: the language selection popup appears only at the very first connection (or after a **second level** reset see § 4.3 Second level reset)

Log into the web site (user/password defaults are adm/adm):

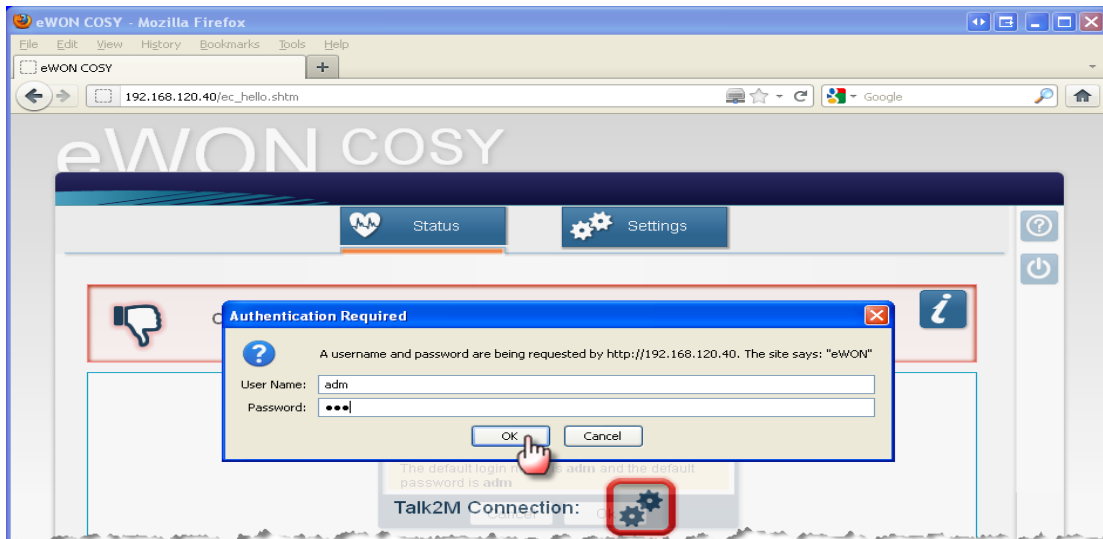

3.4.2 Going through the 1-2-3 Setup Wizard

After login, on a new eWON that was not yet configured the Quick Launch Wizard page opens:

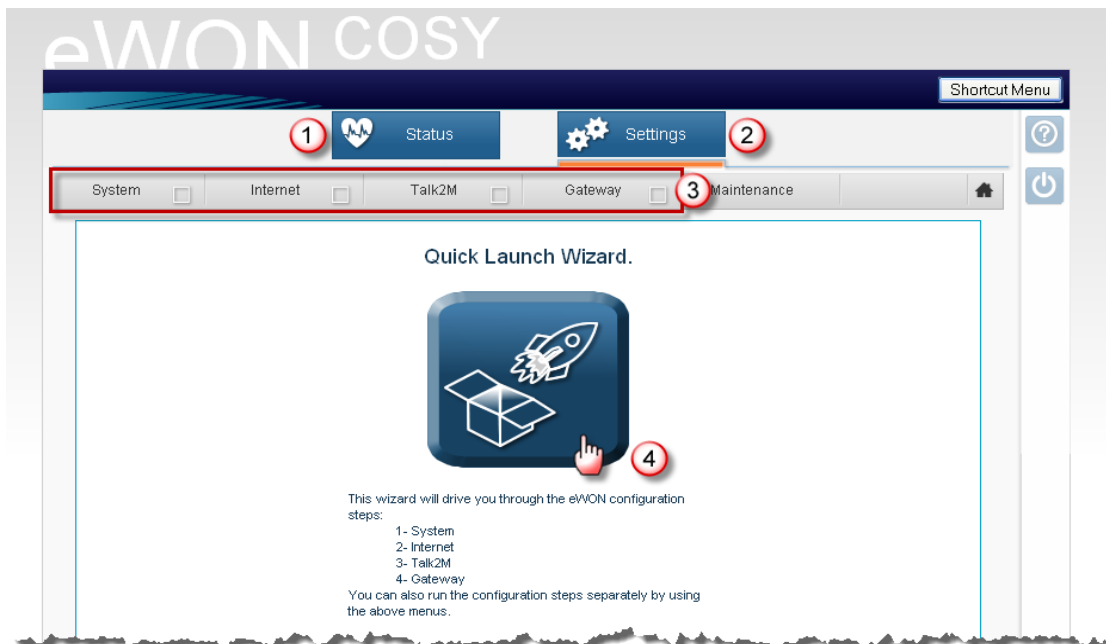

- ① Button to access the Status page for each setup aspect (appears on all pages)
- ② Button allowing to return to this starting page (appears on all pages)
- ③ Direct access to each setup aspect + status check boxes (all unchecked before starting)
- ④ Click this button to go through all steps (follow instructions)

After going through each the wizard, the info bar of the eWON COSY shows checked boxes for each aspect that has been configured.

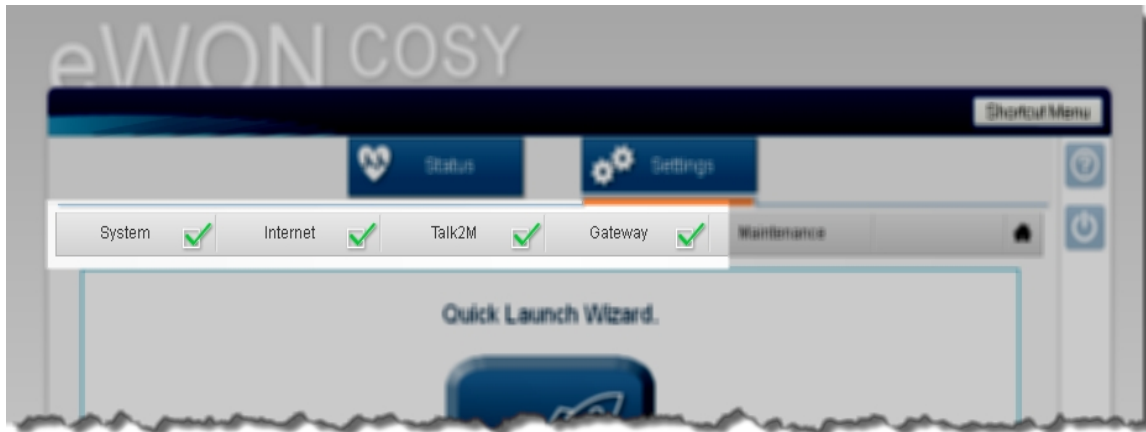

The present installation guide does not cover all setup aspects in details. Each step of the 1-2-3 Setup is documented by a hands-on video tutorial. Go to the eWON COSY support page <http://support.ewon.biz/cosy.htm> to view these videos.

3.5 Status pages

The short form **Status** page that looks like this:

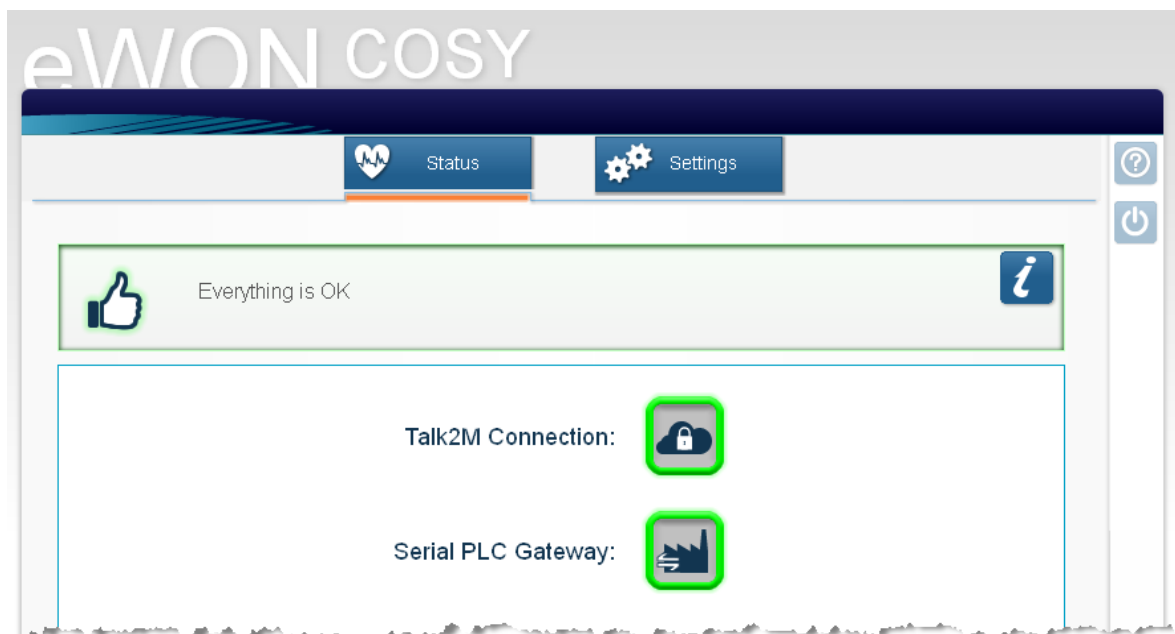

As soon as an eWON COSY has been configured, this short form **Status** page becomes the opening page when connecting to it. The access to this page is not subject to user login. To display this **Status** page from any other page, click the **Status** button in the top navigation bar.

The example below shows how the same **Status** page looks when the Internet connection is locked by the digital input (switch open). To access the detailed **Status** page, click the **i** button in the message box:



Note: access to this page requires to be logged-in.

4. Troubleshooting

4.1 Resetting the eWON COSY

You need a thin tip like an unfolded paper clip to actuate the reset button through the corresponding hole in the front panel. Location, see [Housing interfaces](#).

4.2 First level reset

The first level reset is the most usual level of reset. It consists in formatting only the « user file » part of the non volatile memory. The customer web site, if any exist, belongs to the formatted files.

You generate this first level reset by **pressing and maintaining** the reset button during approximately 4 seconds after powering the eWON up until the **USER** LED flashes RED 1x per second. When this state is reached, release the button and wait approximately 30 secs until the reset procedure is completed. The eWON restarts automatically and is ready to communicate. This type of reset does not modify the communication parameters.

Remain unchanged after a first level reset:

- Selected language
- Internet configuration
- Talk2M configuration (including key)

Return to default after a first level reset:

- System parameters (eWON name & User name and password reset to adm/adm)
- Gateway parameters (reset to status *unconfigured*)

4.3 Second level reset

This second level reset is used only exceptionally because it formats all non volatile memories and returns the eWON to its factory defaults. This operation consists in 3 steps:

- Formatting of all non volatile memories, including all COM parameters and IP addresses
- Full hardware auto test with result shown by the **USER** LED
- Return to ex-factory configuration (default config)

You generate this second level reset by **pressing and maintaining** the reset button during approximately 20 secs after powering up the eWON until the USER LED remains RED steadily. When this state is reached, release the button and wait approximately 90 seconds until the procedure is completed. The procedure finishes with the result of the hardware auto test displayed on the **USER** LED. If the auto test completes successfully, the **USER** LED will blink in RED with a pattern of 200ms ON and 1,5 sec OFF. Any other pattern will start with 200ms ON (opening of the pattern) followed by OFF and a certain number of times 1 sec ON that allows to identify the nature of the detected problem. Please call the technical support if you are confronted with an error pattern on the "USER" LED.

Note: you absolutely have to wait until the full auto test procedure is completed without interrupting it. If the auto test is interrupted, the flash memory of the eWON will contain random data likely to make it unstable. In such a case you have to redo the second level reset procedure from scratch and wait until it is totally completed.

When performing a second level reset, the eWON does NOT restart in normal mode by itself and remains running in diagnose mode. Power the eWON OFF and ON again to restart in normal mode. As described before, the eWON returns to its default COM parameters and factory IP addresses after this level 2 reset is performed.

5. General characteristics of eWON COSY

Characteristic	Value
Processor	ARM clocked @ 75Mhz
SDRAM	16Mb
Flash memory	32Mb
Clock	Backed up real time clock (RTC) Backup battery has 10 years life expectancy
Internet access	1 port 10/100Mb BaseTx Internet access lockable by digital input (DI) Return VPN-tunnel status by digital output (DO)
Ethernet for LAN access	Switch with 4 ports 10/100Mb BaseTx
Serial interface	1 Serial-port configurable in RS232/RS422/RS485 OR 1 MPI-port (up to 12 Mbits/sec)
Mounting	Latch for DIN rail EN50022-compliant
Ambient T°	-20°C to +70°C
Relative Humidity	0 to 80% non condensing

Revision history

Revision Level	Date	Description
1.0	05/01/12	First officially released version
1.1	28/01/12	Changed wizard screen + add § on IP configuration + eBuddy + minor corrections after review
1.2	17/04/12	Correction pinout RS232, page 8

i

Document build number: 52

Note concerning the warranty and the rights of ownership:

The information contained in this document is subject to modification without notice. The vendor and the authors of this manual are not liable for the errors it may contain, nor for their eventual consequences.

No liability or warranty, explicit or implicit, is made concerning quality, the accuracy and the correctness of the information contained in this document. In no case the manufacturer's responsibility could be called for direct, indirect, accidental or other damage occurring from any defect of the product or errors coming from this document.

The product names are mentioned in this manual for information purposes only. The trade marks and the product names or marks contained in this document are the property of their respective owners.

This document contains materials protected by the International Copyright Laws. All reproduction rights are reserved. No part of this handbook can be reproduced, transmitted or copied in any way without written consent from the manufacturer and/or the authors of this handbook

eWON sa, Member of ACT'L Group.