

MAXTECH

**MC-2 SERIES
OPERATION MANUAL**

CONTENT

Dimension & Cut-out	P. 1
Panel function	P. 2
Operation flow	P. 3
How to set special function	P. 7
Specification	P.10
Error information	P.11
Input selection table	P.11
Alarm selection table	P.12
Hookup	P.13
Alarm action description	P.17
Order information	P.18
Available function for MC-2X38.....	P.19

Dimension & Cut-out :

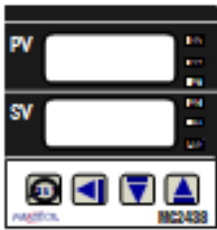

MC-2438

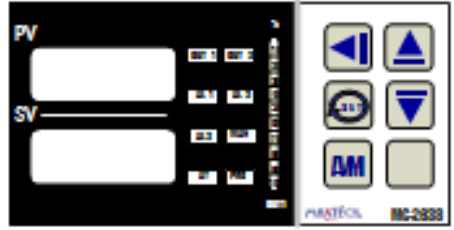

MC-2638



MC-2538

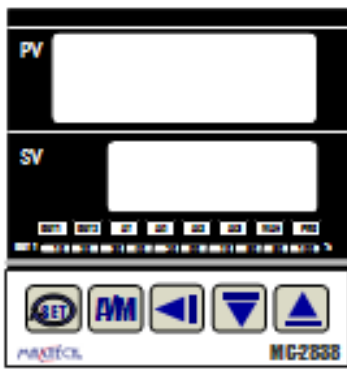

MC-2738

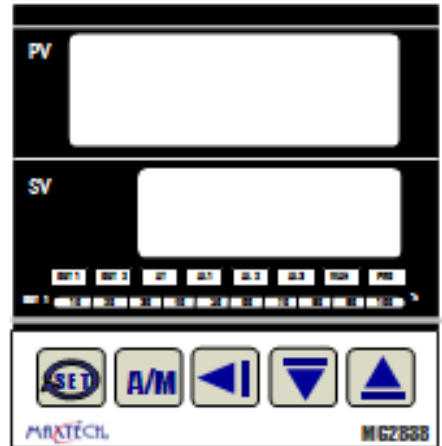

MC-2838

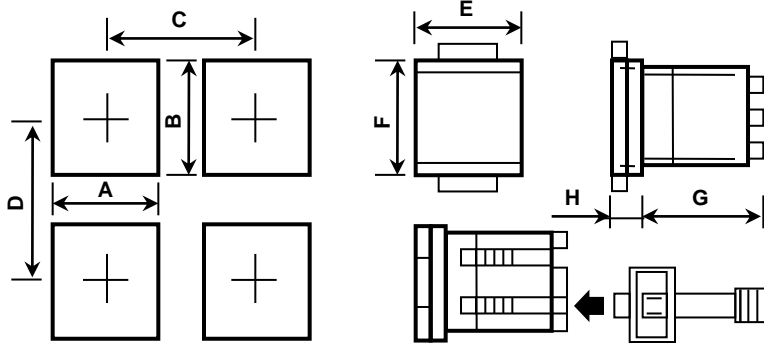





unit : mm

Model	A	B	C	D	E	F	G	H
MC - 2438	44.5 ^{+0.5} ₋₀	44.5 ^{+0.5} ₋₀	65	70	50	50	80	17
MC - 2538	44.5 ^{+0.5} ₋₀	90.5 ^{+0.5} ₋₀	111	116	50	96	80	17
MC - 2638	90.5 ^{+0.5} ₋₀	44.5 ^{+0.5} ₋₀	65	70	96	50	80	17
MC - 2738	68.5 ^{+0.5} ₋₀	68.5 ^{+0.5} ₋₀	89	94	74	74	80	17
MC - 2838	90.5 ^{+0.5} ₋₀	90.5 ^{+0.5} ₋₀	111	116	96	96	80	17

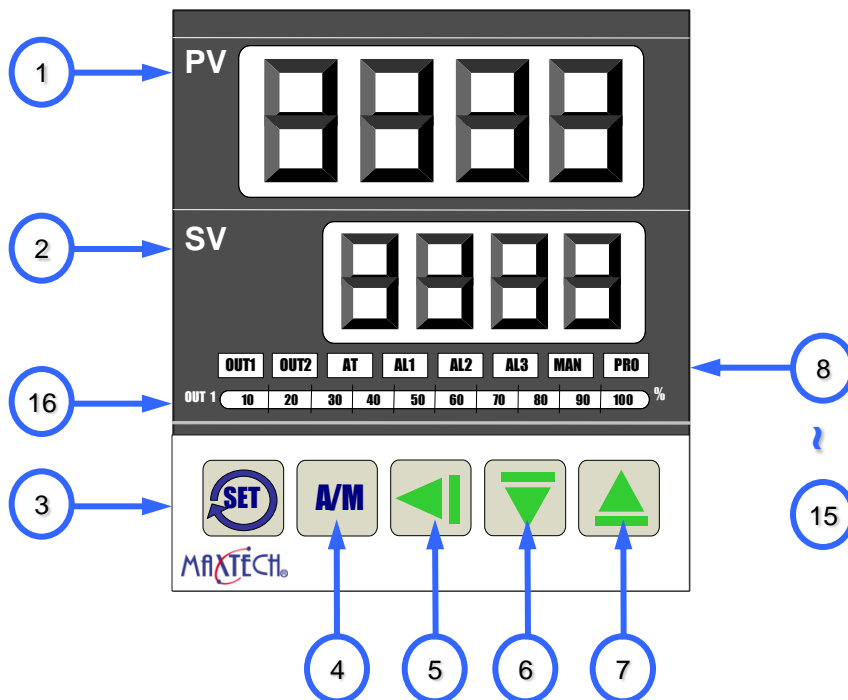
Panel function :

MC-2438/MC-2538/MC-2638/MC-2738/MC-2838



MARKS/DESCRIPTION			MARKS/DESCRIPTION		
1	PV	Process value display	8	OUT 1	Output1 action indication
			9	OUT 2	Output2 action indication
2	SV	Set value	10	AT	Auto tuning action indication
			11	AL 1	Alarm1 action indication
3	SET	Set key & enter key	12	AL 2	Alarm2 action indication
4	A/M	Manual/auto exchange key	13	AL 3	Alarm3 action indication
5		Shift key	14	MAN	Manual action Indication
6		Down key and program suspending key	15	PRO	Programming action indication
7		Up key and Program starting key	16	OUT 1%	Output percentage of out1

Operation flow :

Level1 (User level)

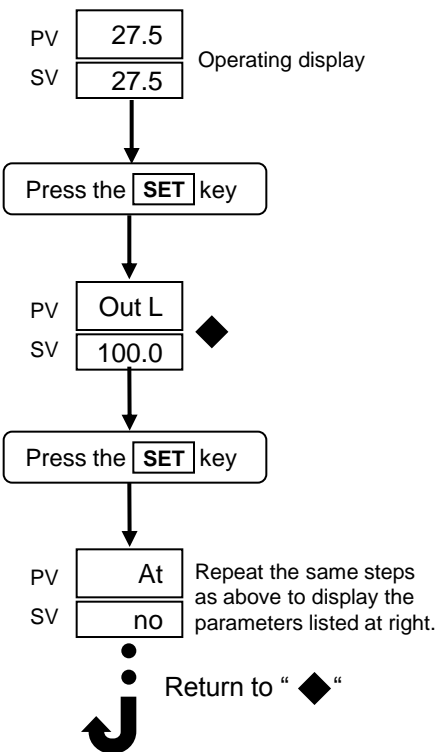

Name		Description	Ex-factory
OUTL	Output percentage	Range of setting:0~100%	Skip
AT	Auto tuning	“RUN/NO” to be used when setting PID	NO
AL1/RAMP/RATE		Alarm setting range: 0-100%F.S. But if select ramp function, it will display “rAmP” setting range from 00.00 to 99.99℃ /min If select soak function, it will display “AL1” setting range from 00.00 to 99.99 min/sec or hour/min. If select slaver function, it will display “rAtE” setting range from 0 to 9999. If select program segment ending alarm function, it will display “AL1”, setting range from 1-8 or 1-16 (AL2 and AL3 are the same as above)	0
AL2/RAMP/RATE			
AL3/RAMP/RATE			

Level2 (PID level)

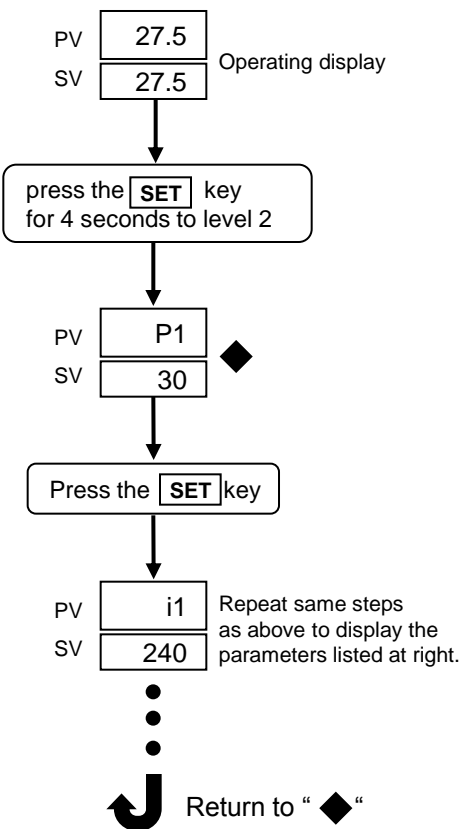

Name		Description	Ex-factory
P1	Main Control Proportional Band	Range of setting:0-100% ON/OFF at P=0	30
I1	Main Control Integral Time	Range of setting:0-3600 Sec Integral off at I=0	240
D1	Main Control Derivative Time	Range of setting:0-3600 Sec Derivative off at D=0	60
DB1	Main Control Dead-band	Dead-band of main control Range of setting:-10+10	0
ATVL	Main Control Auto tuning off-set	Range of setting:0-100% F.S.	0
CYT1	Main Control Output cycle time	When output is SSR, it is set at 3, 4-20 mA is set at 1 but output is relay usually it is set at 20. Range of setting:0-100 Sec	20
HYS1	Main Control Hysteresis	For ON/OFF control only Range of setting :0.0-100	0.4
P2	Sub Control Proportional Band	Range of setting:0-100% ON/OFF at P=0	30
I2	Sub Control Integral Time	Range of setting:0-3600 Sec Integral off at I=0	240
D2	Sub Control Derivative Time	Range of setting:0-3600 Sec Derivative off at D=0	60
CYT2	Sub Control Output cycle time	When output is SSR, it is set at 3, 4-20 mA is set at 1 but output is relay usually it is set at 20. Range of setting:0-100 Sec	20
HYS2	Sub Control Hysteresis	For ON/OFF control only Range of setting :0.4-100	0.4
RST1	Reset1	Adjust offset of output1 when I1 set at “0”	0
RST2	Reset2	Adjust offset of output2 when I2 set at “0”	0
AR	Anti- Integral	Setting range from 0-100 to limit integral	100
LCK	Function Lock	LCK=0000, SV, level 1 & 2 open LCK=0001, SV, open only LCK=0010, SV, level 1 open LCK=0011, lock all except LCK LCK=0100, SV, level 1 & prog. open LCK=0101, SV, level 1,2,3 open LCK=1010, level 4 open only	0101

Level3 (Input level)

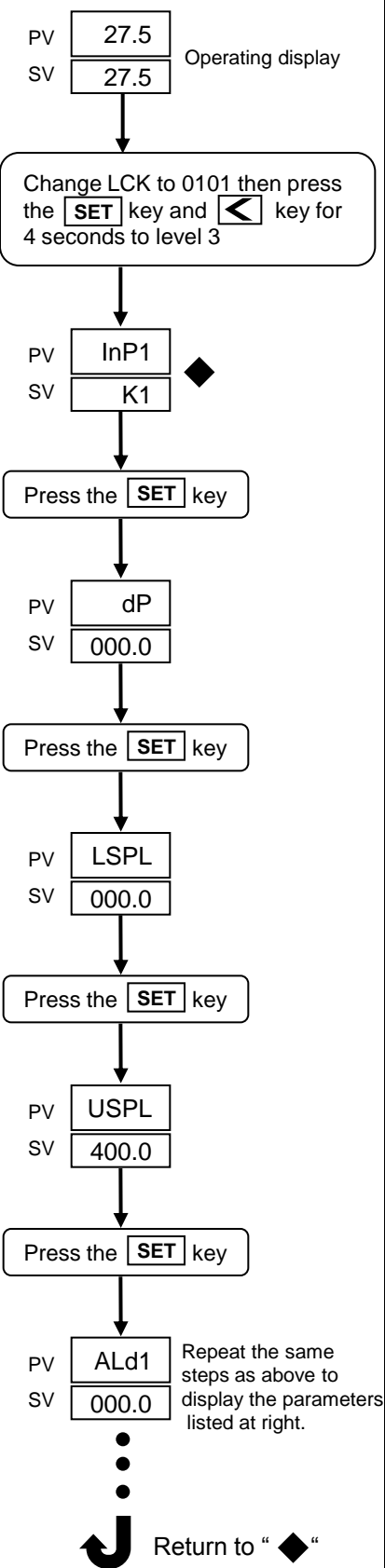

Name		Description	Ex-factory
Inp1	Main input selections	Select the input range, refer to input selection	K1
dP	Decimal point	Set the position of decimal point	000.0
LSPL	Lower set point limit	Set lower point within INP1	0.0
USPL	Upper set point limit	Set highest point within INP1	400
ALd1	Alarm mode of AL1	Range of setting; 00~19	11
ALt1	Alarm 1 time set	It is used in program function. Range: 00~99.59mm, 0=flicker alarm, 99.59=continued alarm, others=on delay time	99.59
ALd2	Alarm mode of AL2	Range of setting: 00~19	11
ALt2	Alarm 2 time set	It is used in program function. Range: 00~99.59mm, 0=flicker alarm, 99.59=continued alarm, others=on delay time.	99.59
ALd3	Alarm mode of AL3	Range of setting: 00~19	11
ALt3	Alarm 3 time set	It is used in program function Range 00~99.59mm 0=flicker alarm 99.59=continued alarm, others=on delay time	99.59
HYSA	Hystersis of alarm	Range of setting: 0.4~100.0	0.4
CLO1	Output1 zero set	Calibrate the low value of output1 Range of setting: 0-2000(current output only)	400
CHO1	Output1 span set	Calibrate the high value of output1 Range of setting; 0-2000(current output only)	2000
OPrL	Transmitter zero set	Calibrate the low value of transmitter Range of setting; 0-2000	400
OPrH	Transmitter span set	Calibrate the high value of transmitter Range of setting; 0-2000	2000
rUCY	The time from open to close of motor	Full run time of proportional motor, Range of setting: 0~150Sec	5
WAit	Use in program for SV wait PV	0=No wait Other=Wait Volume	0.0
idNO	ID number	Communication ID number	1
bAUd	Baud-rate	UART baud rate selection Range of setting:110-38.4K BIT/sec	2.4k
SVOS	Compensate SV	Range of setting:-100.0~100.0	0.0
PVOS	Compensate PV	Range of setting:-100.0~100.0	0.0
Unit	Unit of PV & SV	Range of setting: C,F,A (analog)	°C
SOft	Soft filter	Adjust the response time of PV, the little the faster Range of setting:0~254	200
CASC	Cluster control	(don't care) Range of setting:0~1000	0.0
TOH	The time for loop open	Range of setting:0~120 sec.	60
TsH	The time for loop short	Range of setting:0~120 sec.	20

Level4 (Set level)

This level is for the distributor use only

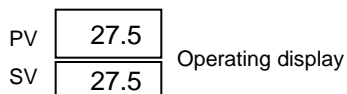

Press the **SET** key for 4 seconds to level 2 and set "1010" in "LCK"

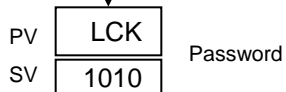

Press the **SET** key and **◀** key for 4 seconds to level 4

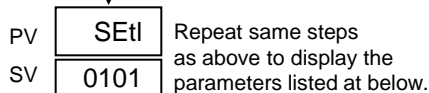

a. Example :

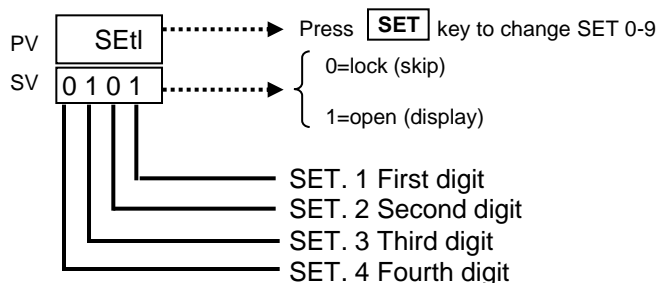

b. Function of set :

Parameter Display	4 th digit	3 rd digit	2 nd digit	1 st digit	
SEt1	AL2	AL1	AT	OUTL	If the digit set at "0" the parameter is skipped. If the digit set at "1" the parameter is opened.
SEt2	D1	I1	PI	AL3	
SEt3	HYS1	CYT1	ATVL	DB1	
SEt4	CYT2	D2	I2	P2	
SEt5	AR	REST2	REST1	HYS2	
SEt6	ALT1	ALD1	LSPL/HSPL	DP	
SEt7	ALT3	ALD3	ALT2	ALD2	
SEt8	RUCY	OPRL/OPRH	CL01/CH01	HYSA	
SEt9	PVOS	SVOS	IDN0/BAUD	WAIT	
SEtA	TSH	CASC	SOFT	UNIT	
SEtb				TOH	
PrOG	0:Program no repeat 1:Program repeat	0:Without power failure 1:With power failure	0:Start from "0" 1:Start from "PV"	0:Alarm during program 1:Program ending alarm	For Program function only
FUNC	0:50Hz 1:60Hz	0:Without loop alarm 1:With loop alarm	0:Without master-slaver function 1:With master-slaver function	0:With RS485 1:With TTL (use for master-slaver)	
TIm2	00:Others 01:Current output or PWM output 10:Transmission output 11:Communication output		0:PV transmission 1:SV transmission	0:Without hold function 1:With hold function	
mOdE	00:PV/SV display 01:Program function 10:Ramp and soak 11:Remote SV		0:Hour/min for time 1:Min/sec. for time	0:Without input2 1:with input2	
Outy	00:Nomal output 01:Motor valve 10:Single phase PWM output 11:Three phase PWM output		00:non 01:heat 10:cool 11:dual output		

Program level :

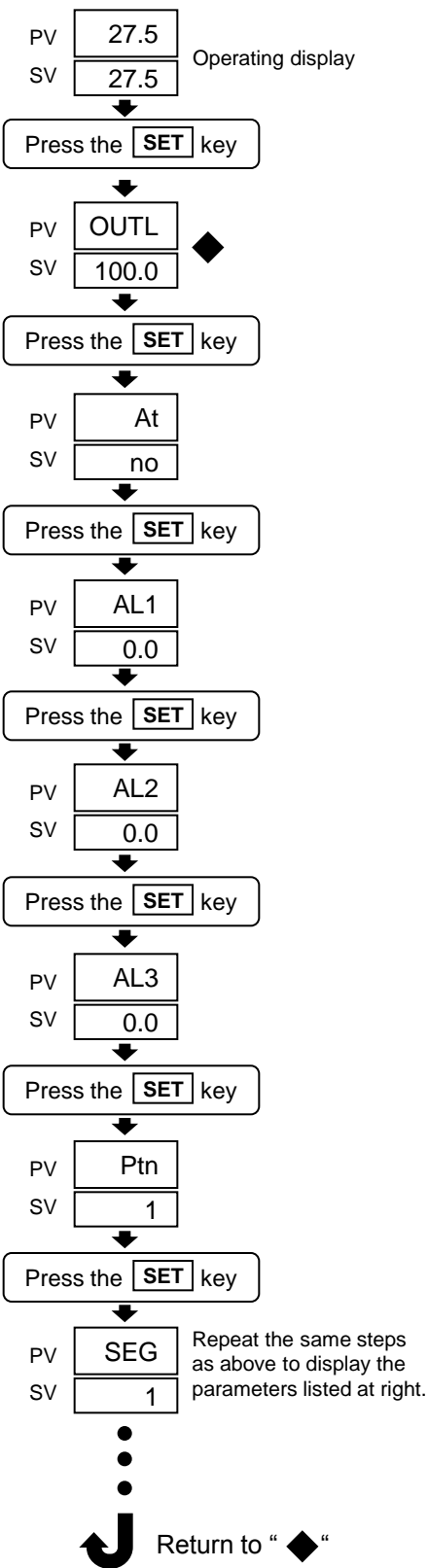

Name		Description
PtN	Set program Pattern	Set pattern "1" at first for 8 segments then set pattern "2" for other 8 segments, pattern 1 & 2 can be performed separately or be linked to make total 16 segments (steps). If it needs to link, set "PIN" to "0" after pattern 1& 2 be set. Range of setting : 0-2
SEG	Program segment display	Range of setting : (1-0)~(2-8)
tMEr	Program timer display	Process time display only
SV-1	Set volume for seg.1	Range of setting : LSPL - USPL
tM-1	Set time for seg.1	Range of setting : 0~99 hours 59 min
OUT1	Set output for Seg.1	Range : 0~100%
SV-2	Set volume for seg.2	Range of setting : LSPL - USPL
tM-2	Set time for seg.2	Range of setting : 0~99 hours 59 min
OUT2	Set output for Seg.2	Range : 0~100%
SV-3	Set volume for seg.3	Range of setting : LSPL - USPL
tM-3	Set time for seg.3	Range of setting : 0~99 hours 59 min
OUT3	Set output for Seg.3	Range : 0~100%
SV-4	Set volume for seg.4	Range of setting : LSPL - USPL
tM-4	Set time for seg.4	Range of setting : 0~99 hours 59 min
OUT4	Set output for Seg.4	Range : 0~100%
SV-5	Set volume for seg.5	Range of setting : LSPL - USPL
tM-5	Set time for seg.5	Range of setting : 0~99 hours 59 min
OUT5	Set output for Seg.5	Range : 0~100%
SV-6	Set volume for seg.6	Range of setting : LSPL - USPL
tM-6	Set output for Seg.6	Range of setting : 0~99 hours 59 min
OUT6	Compensate PV	Range : 0~100%
SV-7	Set volume for seg.7	Range of setting : LSPL - USPL
tM-7	Set time for seg.7	Range of setting : 0~99 hours 59 min
OUT7	Set output for Seg.7	Range : 0~100%
SV-8	Set volume for seg.8	Range of setting : LSPL - USPL
tM-8	Set time for seg.8	Range of setting : 0~99 hours 59 min
OUT8	Set output for Seg.8	Range : 0~100%

How to set special function :

1. Dual output :

It needs installing hardware then enter level 4 (set level) and set "OUTY. 1st & 2nd digit" to "11". Output 1 is for heating and output 2 is for cooling in the meantime. If it needs a gap, DB1 is for setting.

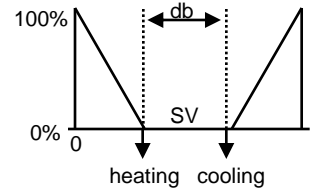

2. Loop broken alarm (loop short or loop open alarm):

It doesn't need installing hardware but has to modify software as following steps.

- Set "ALD1/ALD2/ALD3" to "18" in level 3 and enter level 4 to set "FUNC. 3rd digit" to "1"
- Open "AL1/AL2/AL3" in level 3 and set high/low/ alarm value.
- Open "TOH, TSH" in level 3 and set the time of loop short and loop open.

Principal:

- ✘ When PV is lower 2 °C than low alarm set value within TSH time or PV is higher 2 °C than high alarm set value within TSH time, it is loop short.
- ✘ When PV is higher than high alarm set value, but it doesn't drop 0.5 °C in TOH time or PV is lower than low alarm set value but it doesn't raise 0.5 °C in TOH time, it is loop open.

3. Program:



It doesn't need installing hardware but has to modify software as following steps.

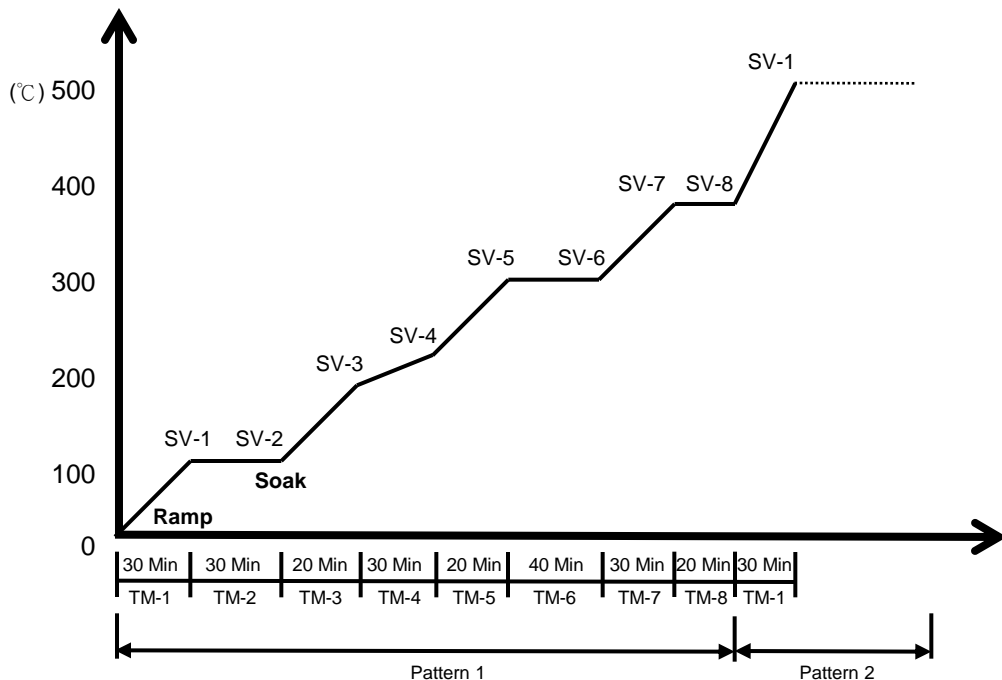



- Open "MODE" in level 4 and set "mode. 3rd & 4th digit" to "01" then the parameter of process will be displayed in window.
- Change "LCK" to "0100" then it can set program parameter. The program has 2 patterns, each pattern contains 8 segments. 2 patterns can be linked together to 16 segments.
- The "PTN" parameter set to "1", it will display first section of 8 segments. The "PTN" parameter set to "2" it will display second section of 8 segments. If "PTN" is changed to "0" after setting PTN1 & PTN2, the program will be linked together to 16 segments.
- Each segment can be arranged as ramp or soak; ramp is for changing SV with time while soak is for keeping SV with time.



e. If next segment's "OUT" set to "0", the program will end at this segment. If the program needs repeat, it has to enter level 4 and set "PROG. 4th digit" to "1".

f. Function key for program:

In the initial window status, pushing "up" key  for 4 sec., the program start and "pro" LED flickers, pushing "down" key  for 4 sec., the program pause and "PRO" LED keeps light.

If pushing "UP" key  first then pushing  key again, the program will jump to next segment, but if pushing "down" key  first then pushing  key again, the program will end immediately and "PRO" LED is "off".

g. Alarm function for program:

1).Segment ending alarm

"AL1/AL2/AL3" & "ALD1/ALD2/ALD3" in level 3 must be set.

example: Set "ALD1" to "07"

Set "AL1" to "2", the alarm function will perform in segment 2

Set "ALT1" to "00.20 M/S." the alarm will perform 20 sec., 00.20 H/M. the alarm will perform 20 MIN If set it to "0" the alarm is in flicker but if set it to "99.59" the alarm is in continuance.

2).Program ending alarm:

"ALD1/ALD2/ALD3" in level 3 must be set.

example: Set "ALD2" to "17", if the "PROG. 1st digit in level 4" set "1", the alarm2 will perform when the program end, but if the "PROG. 1st digit" set "0", the alarm2 will perform during program process then it stops when the program end.

h. Other functions:

1).Power failure function:

If the "PROG. 1st digit" set "1", it has power failure function the program will perform again from stopped segment when the power is recovered. On the contrary, if the "PROG. 1st digit" set "0", it hasn't power failure function, the program always perform again from first segment when the power is recovered.

2).When the program start from first segment, if "the PROG. 2nd digit" set "1", it will start according to "PV" but if the "PROG. 2nd digit" set "0", it will start according to "0", if it is set to start from PV, the controller will check PV & SV-1 which is small if PV is small it will start from PV but if SV-1 is small it will start from SV-1.

3).Wait function:

If the "WAIT" parameter in level3 set "0", it has not wait function, but if it sets other volume the SV will wait the PV when the PV exceed the SV over the set volume.

4.Remote SV function:

a. It needs modifying hardware (contact the distributor)

b. Set the "MODE. 1st digit" to "1" and the "MODE. 4th & 3rd digit" to "11" in level 4.

5.Master and slaver function:

a. Both master and slaver need installing TTL communication hardware.

b. The master unit must be with program function, then setting its "TIM2. 4th & 3rd" to "11" and "FUNC. 1st digit" to "1" in level4. in addition to set "IDNO" parameter to "0" and "BAUD" parameter with ideal volume in level3.

c. The slaver unit must be without program function, then setting "TIM2. 4th & 3rd digit" to "11", "FUNC. 2nd digit" to "1" "MODE. 4th & 3rd digit" to "11" and "MODE. 1st digit" to "0" in level4 in addition to set among "ALD1/ALD2/ALD3" to "0" in level3. In this case one among "AL1/AL2/AL3" will convert to "RATE" function.

- d. The “RATE” parameter is for setting how many percentage of SV in Slaver unit according with master unit. For example, if the master SV is “1000” then we set “RATE” to “90” in slaver, the SV of slaver will be “900”.
- e. One set of alarm can be used for “RATE” only.

6.Ramp and Soak function:

It doesn't need installing hardware but has to modify software as following steps.

- a. Set “MODE. 4th & 3rd digit” to “10” in level4.
- b. For ramp function , it needs setting one among “ALD1/ALD2/ALD3” to “9” then one among “AL1/AL2/AL3” will convert to “ramp” function. Setting unit for “RAMP” is “xx.xx °C/MIN.”, and the PV will raise according to setting volume until it finishes.
- c. For soak function, it needs setting “MODE. 1st digit” to “0” for H/M or “1” for M/S, and one among “ALD1/ALD2 /ALD3” must be set to “19”, then one among “AL1/AL2/AL3” will convert to “soak” function and a time can be set among “AL1/AL2/AL3”. When the PV reach the SV, it starts time counting, in the meantime one among “AL1/AL2 /AL3” and time will display alternately. When the time reach setting volume, the alarm perform and the control output stop.
- d. One set of alarm can be used for ramp and one set of alarm can be used for soak only.

7.Motor valve control function:

- a. It needs installing hardware. (contact the distributor).
- b. Set “MODE. 1st digit” to “1” in level4 to open second input.
- c. Set “OUTY. 4th & 3rd digit” to “01” in level4 to open motor valve control function.
- d. Set “CYT1” to open/close cycle time of motor valve in level2 and “RUCY” to time from open to close of motor valve in level3.
- e. The LED bar on the panel will display the position of motor valve.
- f. Second input is for feedback use, it has 4~20mA,0~10mA,0~10VDC,2~10VDC,0~5VDC,1~5VDC or potentiometer.

8.SCR control output (resistance load only):

- a. It needs installing hardware (contact the distributor).
- b. Set “TIM2. 4th and 3rd digit” to “01” in level4 to open PWM output function.
- c. Set “OUTY. 4th and 3rd digit” to “10” in level4 to open single phase function or “11” to open three phase function.

9.Analogue output function:

- a. It needs modifying hardware, there are 4~20mA, 0~20mA, 0~5VDC, 0~10VDC, 1~5VDC, 2~10VDC. (contact the distributor).
- b. Set “CLO1” to lowest limit in level3. For example, if lowest output is 4mA, then set it to “400”.
- c. Set “CHO1” to highest limit in level3. For example, if highest output is 20mA, then set it to “2000”.
- d. Set “TIM2. 4th and 3rd digit” to “01” in level4 to open PWM function.
- e. Set “OUTY. 4th and 3rd digit” to “00” in level4.

10.Analogue input (Input 1 only):

- a. It needs modifying hardware, there are 0~10mA,4~20mA,0~1VDC,0~5VDC,0~10VDC (contact the distributor).
- b. Set “INP 1” to “AN1~4” in level3, and set “LSPL” to lowest range, “USPL” to highest range in level3.
- c. Set “LCK” to “0111” in level 2.
- d. Push **SET** key and **◀** key for 4 sec. until “INPL” is displayed on upper window.
- e. Send input signal for lowest range until display is stable, then push **SET** key to enter.

f. Send input signal for highest range when upper window displays "INPH".

g. Push **SET** key when "INPH" is stable.

11. Transmitter output:

a. It needs installing hardware (contact the distributor).

b. Set "TIM2. 4th and 3rd digit" to "10" in level4 to open transmitter function.

c. Set "TIM2. 2nd digit" to "0" in level4 for PV transmitter or to "1" for SV transmitter.

d. Set "OPRL" to lowest range and "OPRH" to highest range in level3.

12. Communication function:

a. It needs installing hardware (contact the distributor).

b. Set "FUNC. 1st digit" to "0" to RS485 function.

c. Set "TIM2. 4th & 3rd digit" to "11" to open communication function.

d. Set "IDNO" parameter to address and "BAUD" parameter to ideal volume in level3.

e. Refer to communication protocol.

13. Auto/manual switch function:

a. It doesn't need installing hardware.

b. Push **A/M** key for 4 sec. under auto status, it converts to manual control function. In this case, the "MAN" LED light and the volume of output will be controlled by "OUTL" which can be adjusted with **▲** or **▼** key to increase or decrease. For example, set "OUTL" to "50", the output volume always keep 50% until "OUTL" is changed.

c. Push **A/M** key for 4 sec. under manual status, it converts to auto control function.

d. MC-2438 series don't have this function.

Specification :

1). Input (Main) :

1. T/C Thermocouple S, B, R, K, E, J, W, N, Cu or PT100, selectable.

2. DC V : -10~10mV, 0~10mV, 0~20mV, 0~50mV, 0~1V, 0~5V, 0~10V selectable.

3. DC mA : 0~20mA, 4~20mA, selectable or others to be ordered.

4. Input (Sub) :

Remote set: 4~20mA, 0~10V to be ordered.

2). Output :

1. Relay output : SPST, SPDT, 5A/240VAC.

2. SSR drive : 20mA/20VDC.

3. Current proportioning output : 4~20mA adjustable (Load max 300Ω).

4. 3 wire system motor valve control 5A/240VAC (with feed back)

5. Alarm : SPST 5A/240VAC for MC-2438, 2738
SPDT 5A/240VAC for other models.

3). Control mode :

1. ON/OFF : sensitivity adjustable

2. P (Proportional) : 0~100% adjustable

3. I (Integral) : 0~3600 sec adjustable

4. D (Derivative) : 0~3600 sec adjustable

5. Proportioning cycle time : 0~100 sec adjustable

(mA=1, SSR=3, RY>=20)

4). Electrical characters tics :

1. Working voltage : AC85~265V, DC15~50V

2. Power consumption : 2VA

3. Isolated resistance : 20MΩup

4. Dielectricity strength : AC2000V/50/60Hz
1min

5. Sampling time : 250m sec

6. Accuracy : +-0.2% of full range +-1 digit

5). Mechanical characters tics :

1. Working temperature : -10~+50°C

2. Storage temperature : -10~+70°C

3. Working humidity : 50~+85%RH

4. Weight :

MC-2438 about 190g

MC-2538 about 310g

MC-2638 about 310g

MC-2738 about 310g

MC-2838 about 410g

Error information:

Parameter Display Code	Description
In1E	Open circuit of main control sensor
* AdCF	A/D convector failed.
* CJCE	Cold junction compensation failed.
In2E	Open circuit of sub control sensor.
uuu1	PV exceeds USPL
nnn1	PV under LSPL
uuu2	Input signal of sub control exceeds the upper limit.
nnn2	Input signal of sub control under the upper limit.
* rAmF	RAM failed.
IntF	Interface failed.
AutF	Auto tuning failed.

NOTE: If the “ * ” marked error occurs, the Temperature Controller need repair.
Please send it to the nearest sales office or retail dealer.

Input selection table:

Type	Code	Range
S	S	0~1600℃
B	b	0~1800℃
R	r	0~1700℃
K	k1	0.0~400.0℃
	k2	0~1300 ℃
E	E1	0.0~300.0℃
	E2	0~600℃
T	t	0.0~400.0℃
J	J1	0.0~400.0℃
	J2	0~800℃
WU3-RE25	w	0~2000℃
n	n	0~1300 ℃
PT	Pt1	-199.9~199.9 ℃
	Pt2	-200~800 ℃
CU50	CU50	-50.0~150.0 ℃
AN1	An1	0~20MV/-1999~9999
AN2	An2	0~50MV/-1999~9999
AN3	An3	0~5V/-1999~9999
AN4	An4	4~20MA/-1999~9999

Alarm selection table:

Code	Description	Inhibit
00	None or master & solver function use.	-
10	Deviation high limit alarm	-
01	Deviation high limit alarm	YES
11	Deviation high limit alarm	NO
02	Deviation low limit alarm	YES
12	Deviation low limit alarm	NO
03	Deviation high / low limit alarm	YES
13	Deviation high / low limit alarm	NO
04 / 14	Dand alarm	NO
05	Absolute value high limit alarm	YES
15	Absolute value high limit alarm	NO
06	Absolute value low limit alarm	YES
16	Absolute value low limit alarm	NO
07	Segment end alarm (use for program model only)	-
17	Segment run alarm (use for program model only)	-
08	System error alarm-(on)	-
18	System error alarm-(off) or loop broken alarm	-
09	Ramp	-
19	Soak (On delay timer alarm)	-

Hookup :

MC-2438

A. Power Supply

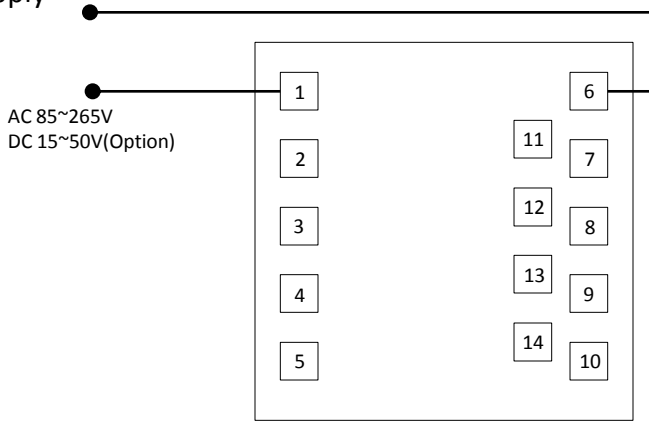

G. Remote

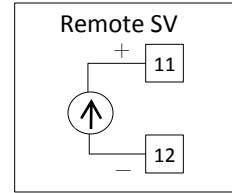

B. Control Output

OUT1 Relay,SSR,mA,V

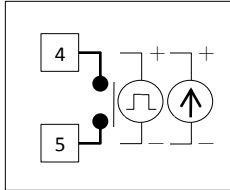

OUT2 Relay,SSR

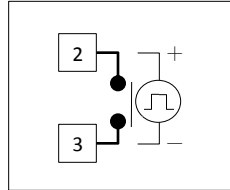

(Option)

OUT1 (Proportional Motor Valve Control)

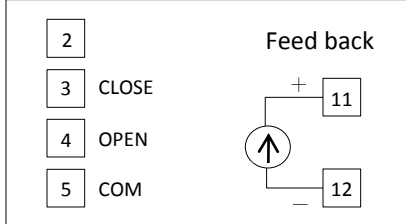

C. Input

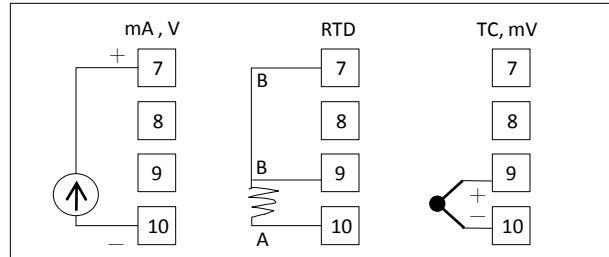

D. Alarm

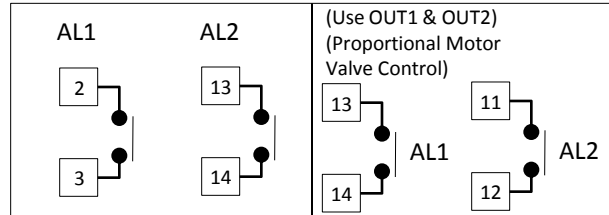

F. Communication

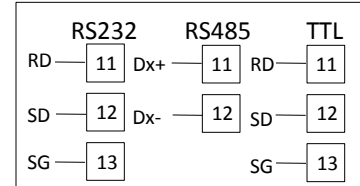

E. Retransmission

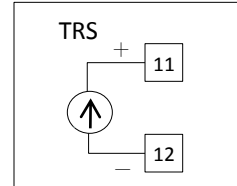

Hookup :

MC-2738

A. Power Supply

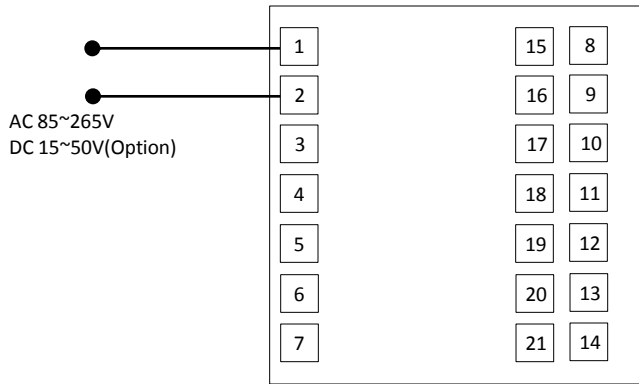

B. Control Output

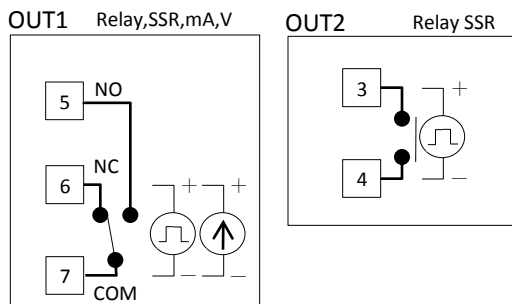

(Option)

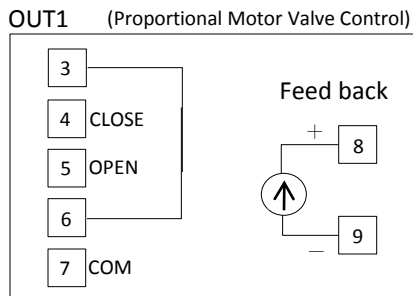

C. Input

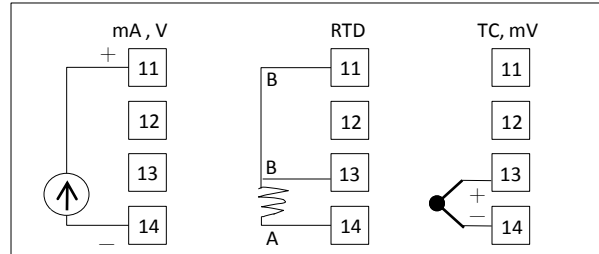

D. Alarm

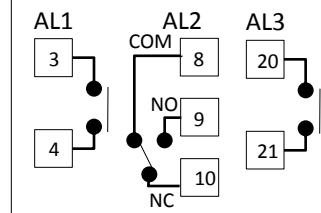

E. Retransmission

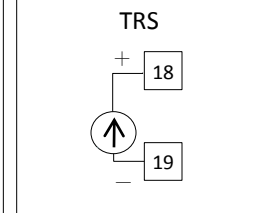

G. Communication

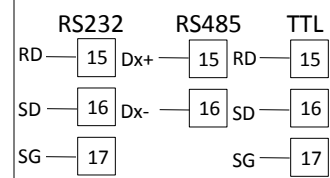

F. Remote

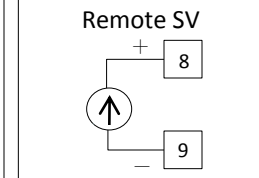

Hookup :

MC-2538

MC-2638

A. Power Supply

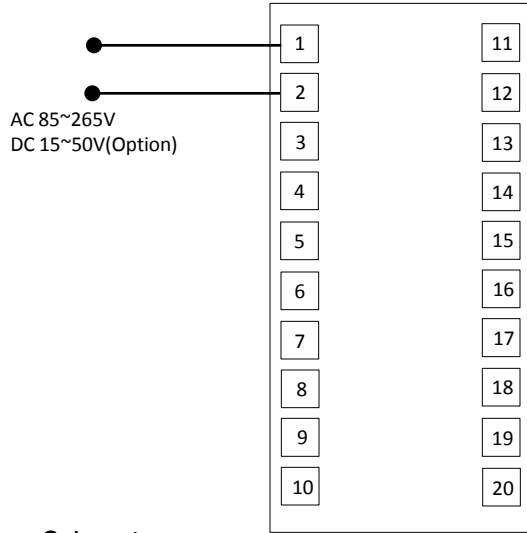

B. Control Output

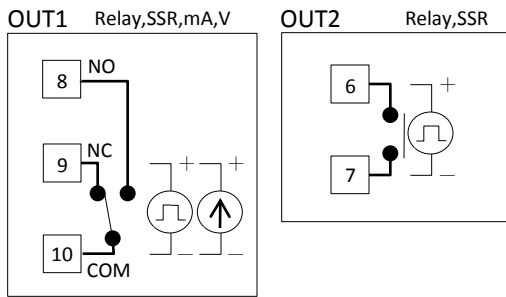

(Option)

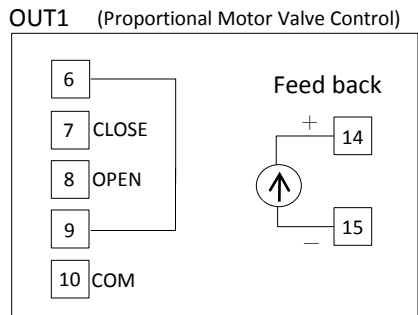

C. Input

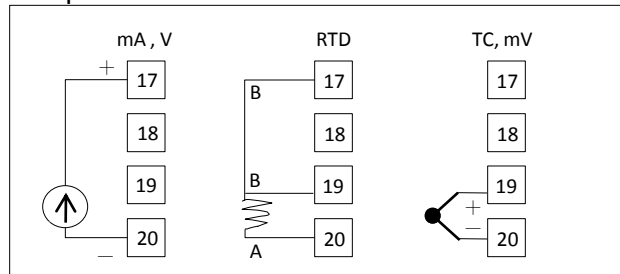

D. Alarm

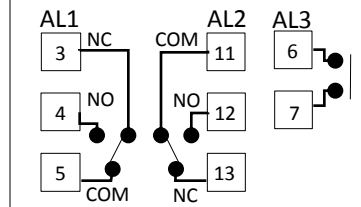

E. Retransmission

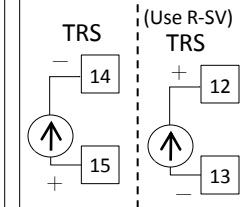

G. Communication

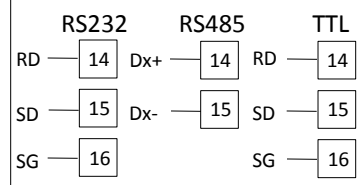

F. Remote

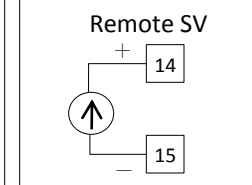

Hookup :

MC-2838

A. Power Supply

AC 85~265V
DC 15~50V(Optional)

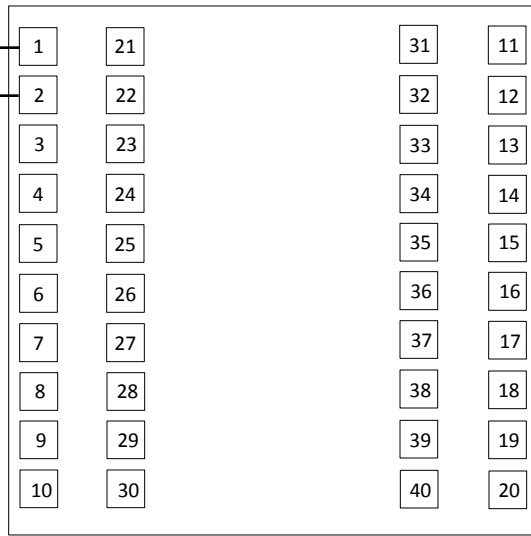

B. Control Output

OUT1 Relay,SSR, mA, V

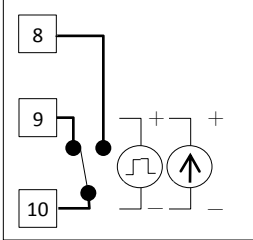

OUT2 Relay,SSR

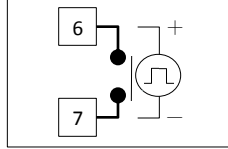

C. Input

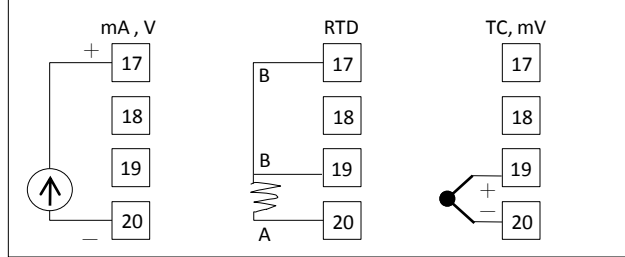

(Option)

OUT1 (Proportional Motor Valve Control)

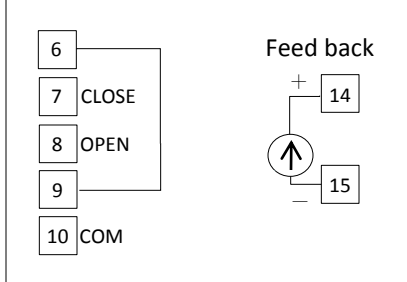

D. Alarm

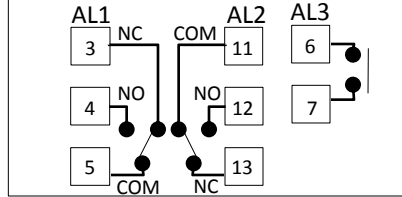

F. Remote

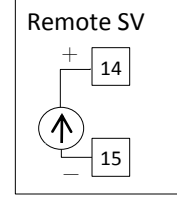

E. Retransmission

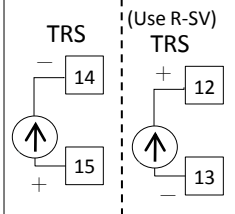

G. Communication

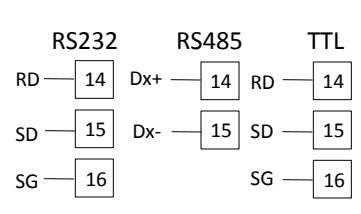

Alarm action description:

▲ : SV

△ : Alarm set value

(Inhibit means alarm doesn't work at first time)

00	Non
10	
01	Deviation high alarm inhibit
11	Deviation high alarm no inhibit
02	Deviation low alarm inhibit
12	Deviation low alarm no inhibit
03	High low alarm inhibit
13	High low alarm no inhibit
04	Band alarm
14	
05	Absolute high alarm inhibit
15	Absolute high alarm no inhibit

06	Absolute low alarm inhibit
16	Absolute low alarm no inhibit
07	Segment end alarm (use for Program Model only) (1) ALD1~3, set 07 (2) AL1~3 = alarm segment No.set (3) ALT1~3 if set 0 = flicker alarm ALT1~3 if set 99.59 = continued alarm ALT1~3 if set others = ON delay time
17	Program Run alarm (use for Program Model only)
08	System error alarm – ON
18	System error alarm - OFF
09	Ramp
19	On delay timer When PV= alarm SV , it keeps a certain period (set time) before alarm action Range:00H00M~99H59M

Order information :

MC - 2438 - 101 - 001
A BCD EFG

A-Model NO:

MC-2438 with size 48x48mm(DIN 1/16)
MC-2538 with size 48x96mm(DIN1/8)
MC-2638 with size 96x48mm(DIN1/8)
MC-2738 with size 72x72mm
MC-2838 with size 96x96mm(DIN1/4)

B-Out 1 control output mode for heating or cooling:

0-None
1-Relay contact, SPDT 5A/240VAC
2-SSR Voltage pulse,20VDC/20mA
3-Current, 4-20mA
4-3 wire system motor valve control 1a contact
5A/240VAC(with feed back)
5-1 phase zero cross SCR
6-3 phase zero cross SCR
8-1 phase SCR
9-3 phase SCR
A-0~5V
B-0~10V
C-1~5V
D-2~10V

C-Out 2 control output mode for cooling:

0-None
1-Relay contact, SPDT 5A/240VAC
2-SSR Voltage pulse,20VDC/20mA
3-Current, 4-20mA
A-0~5V
B-0~10V
C-1~5V
D-2~10V

D-Alarm:

0-None
1-One set alarm
2-Two set alarm
3-Three set alarm
*(except MC-2438)

E-Transmitter:

0-None
1-4~20mA (Adjustable)
2-0~20mA (Adjustable)
A-0~5V
B-0~10V
C-1~5V
D-2~10V

F-Second Input:

0-None
1-4~20mA remote set point
2-0~20mA remote set point
A-0~5V remote set point
B-0~10V remote set point
C-1~5V remote set point
D-2~10V remote set point

G-Communication:

0-None
1-RS232
2-RS485
3-TTL communication
(Master & Slave)

Available Function For MC-2X38

NO.	1	2	3	4	5	6	7	8
Functions	OUT2	ALM2	ALM3	R-SV	TRS	MOTOR VALVE	RS485	MASTER & SLAVE
MC-2438	V	V		V	V	V	V	V
MC-2538	V	V	V	V	V	V	V	V
MC-2638	V	V	V	V	V	V	V	V
MC-2738	V	V		V	V	V	V	V
MC-2838	V	V	V	V	V	V	V	V

MC-2438 ① ⑥ select 1
 ④ ⑥ select 1
 ② ⑤ ⑦ ⑧ select 1

MC-2738 ① ⑥ select 1
 ② ④ select 1
 ⑤ ⑦ ⑧ select 1
 ④ ⑥ select 1

MC-2538 while use ④ or ⑥ , ② ⑤ ⑦ select 1

MC-2638

MC-2838

① ③ ⑥ select 1
 ④ ⑥ ⑧ select 1